

BaanERP (Grieg SP4)

**Definition of BEMIS V ORD001A
Import and Export File for the Message
Trading Orders**

A publication of:

Baan Development B.V.
P.O.Box 143
3770 AC Barneveld
The Netherlands

Printed in the Netherlands

© Baan Development B.V. 1999.
All rights reserved.

The information in this document is subject to change without notice. No part of this document may be reproduced, stored or transmitted in any form or by any means, electronic or mechanical, for any purpose, without the express written permission of Baan Development B.V.

Baan Development B.V. assumes no liability for any damages incurred, directly or indirectly, from any errors, omissions or discrepancies between the software and the information contained in this document.

Document Information

Code: U7316A US
Group: User Documentation
Edition: A
Date: August, 1999

Table of contents

1	General Principles	1-1
	Available kinds of data records	1-1
	Branching diagramm	1-2
	Key fields outgoing	1-4
	Key fields incoming	1-4
	Network directories	1-5
	BEMIS V Messages - Conventions	1-6
	What is new in comparison to BEMIS for BAAN IV	1-9
2	Data record description by kind of data record	2-1
	SA1 MESSAGE OVERHEAD	2-1
	SA2 ORDER HEADER	2-13
	SA3 ORDER TEXT - <i>TEXTDATEN</i>	2-45
	SA4 Order Specific Addresses	2-51
	<i>First Appearance: Ship From Business Partner Address (Address Qualifier: SFBP)</i>	2-51
	<i>Second Appearance: Warehouse Address (Address Qualifier: CWAR)</i>	2-54
	<i>First Appearance: Ship from Business partner Address (Address Qualifier: SFBP)</i>	2-57
	<i>Second Appearance: Warehouse Address (Address Qualifier: CWAR)</i>	2-70
	SA5 Order Lines	2-83
	SA6 Ship from Business Partner Address per Order Line	2-123
	<i>First Appearance: Warehouse Address (Address Qualifier: CWAR)</i>	2-123

Definition of BEMIS V ORD001A Import and Export File for the Message Trading Orders
ii

About this document

This documentation describes in a detailed way the standard inhouse data formats, which the BAAN Electronic Message Interchange System BEMIS V requires as interfaces to the respective EDI Sub-System.

The documentation is intended for developers of EDI Sub-Systems, which want to realize an interface of their software to BAAN ERP. Furthermore, it supports consultants, who want to implement and verify such an interface within a customer project.

Chapter 1 gives an overview over the general principles of the relevant EDI message. For example available kinds of data records, message structure, key fields and other conventions.

Chapter 2 describes all corresponding kinds of data records for the EDI message in a detailed way. All data fields are listed in an overview table in connection with the corresponding table fields. In addition, every single field is described in a more detailed way. You will find information about the general conditions, which you need to observe for the processing in the EDI Sub-System or in BAAN ERP.

1 General Principles

This section describes the BAAN EDI inhouse format for the message type *Orders (incoming/outgoing)*.

Available kinds of data records

The use of the following kinds of data records is conditional (C) respectively mandatory (M), when you transmit information about orders.

Id	Status	Name
SA1	M	Overhead
SA2	M	Order Header
SA3	C	Order Header Text
SA4	C	Order Warehouse / Invoice Addresses
SA5	M	Order Line
SA6	C	Order Line Warehouse Addreses

Branching diagramm

The following data record structure is used for the message type BEMIS V - Orders:

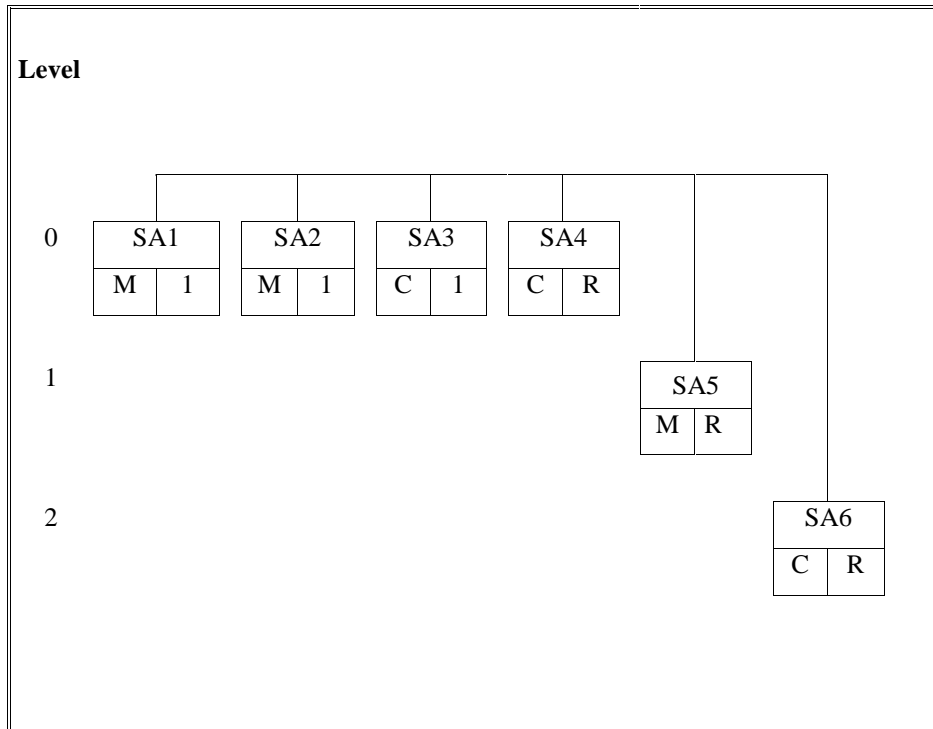

Legend:

Status:

M: mandatory in message

C: conditional in message

Frequency:

1: once by message

R: repeatable by message

For example, for two required orders with each two lines the BEMIS V file has the following structure:

```
SA1 ... BAAN ERP Overhead
SA2 ... Order Header 1
SA3 ... Order Header 1 Text
SA4 ... Order Address Order 1
SA4. ... Order Address Order1
SA5 ... Order Lines Item 1
SA6 ... Order Line Delivery Address Item 1
SA5... Order Line Item 2
SA6 ... Order Line Delivery Address Item 2
...
```

```
SA1 ... BAAN ERP Overhead
SA2 ... Order Header 2
SA3 ... Order Header 2 Text
SA4 ... Order Address Order 2
SA4... Order Address Order 2
SA5 ... Order Lines Item 1
SA6 ... Order Line Delivery Address Item 1
SA5... Order Line Item 2
SA6 ... Order Line Delivery Address Item 2
...
```

Key fields outgoing

The following structure of the key fields is used to determine the related data records of an order:

Kind of data record	Key field 1	Key field 2	Key field 3	Key field 4
SA1	Message Reference	Identification Sender		
SA2	Message Reference	Identification Sender		
SA3	Message Reference	Identification Sender	Order Number	
SA4	Message Reference	Identification Sender	Order Number	
SA5	Message Reference	Identification Sender	Order Number	
SA6	Message Reference	Identification Sender	Order Number	Order Position Number

Key fields incoming

The following structure of the key fields is used to determine the related data records of an order message:

Kind of data record	Key field 1	Key field 2	Key field 3	Key field 4
SA1	Message Reference	Identification Sender		
SA2	Message Reference	Identification Sender		
SA3	Message Reference	Identification Sender	Customer Purchase Order Number	
SA4	Message Reference	Identification Sender	Customer Purchase Order Number	
SA5	Message Reference	Identification Sender	Customer Purchase Order Number	
SA6	Message Reference	Identification Sender	Customer Purchase Order Number	Order Position Number

Network directories

The so-called network directories form the basis of the communication between the EDI Sub-System and BAAN ERP. These directories are established in BAAN. The network basis directories for each network will be defined in the BAAN session SEecedi0120m000. For the network BEMISV, the basis directories can be indicated in the following way:

/auto3/baanerp/bemis5/order/

BAAN will additionally create the following subdirectories:

/auto3/ baanerp /bemis5/order/appl_from/

/auto3/ baanerp /bemis5/order/appl_to/

/auto3/ baanerp /bemis5/order/command/

/auto3/ baanerp /bemis5/order/store_rcv/

/auto3/ baanerp /bemis5/order/store_sent/

/auto3/ baanerp /bemis5/order/trace/

The above mentioned directories have the following function:

- 1 **.../appl_from/:** In this directory, BAAN ERP records the outgoing messages which are the defined BEMIS V inhouse format files. The EDI Sub-System can collect them from here.
- 2 **.../appl_to/:** The EDI Sub-System writes the incoming message into this directory in the BAAN ERP inhouse format.
- 3 **.../command/:** Directory of the semaphores.
- 4 **.../store_rcv/:** BAAN ERP stores in this directory processed incoming messages, if the configuration is accordingly. During this process an additional subdirectory by incoming message file will be created which is named with a date and time stamp indicating when the message was moved.
- 5 **.../store_sent/:** BAAN ERP stores in this directory processed outgoing messages if the configuration is accordingly. During this process an additional subdirectory by incoming message file will be created which is named with a date and time stamp indicating when the message was moved.
- 6 **../trace/:** BAAN ERP creates under this directory a log of the incoming and outgoing messages in the processing order, if the configuration is accordingly.

For every message type one network directory will be used for outgoing and one for incoming messages. This means that one message file contains data for several business partners.

The file name of the BEMIS V inhouse format file of the order, which is being described in this documentation, is defined in the following way:

Direction	File name	Network directory
outgoing	ord001.txt	../appl_from
incoming	ord001.txt	../appl_to

BEMIS V Messages - Conventions

The following general rules apply to a message record in a BEMIS V message file:

- 1 Every message record starts with "SAX"
- 2 Every message record ends with "SAX_END"
- 3 The length of a data record can vary.
- 4 The message record must consist of all fields, even if not every field contains a value.
- 5 The fields in the file must be separated by a ; .
- 6 A filled string field have to be put in "...".

In the following sections you will find the format descriptions for the individual kinds of data records of the interface file. The table contains the following data:

<i>ORDER INHOUSE FORMAT</i>				
<i>Pos</i>	<i>FIELD DESCRIPTION</i>	<i>Key</i>	<i>ST</i>	<i>FM</i>

The first block of the table describes the format of a kind of data record:

Pos.	Position of the field in the data record
Field description	Description of the field
Key	Key field outgoing (O) / incoming (I)
ST	Field status mandatory (M) / conditional (C)
FM	Field format
	an..14 alphanumerical field with a maximum of 14 characters
	an14 alphanumerical field with exactly 14 characters
	n..10 numerical field with a maximum of 10 characters
	n1 numerical field with exactly 1 character

<i>from Application Table Fields (out) / Mapping to (in)</i>	
<i>Table Field</i>	<i>Action</i>

The second block of the table describes the corresponding table field in BAAN ERP as well as possible special actions, which will be carried out during the processing of the messages.

Following the table overview, every field is described in a more detailed way, including information about the processing in the EDI Sub-System and in BAAN ERP.

In the past, there seemed to be some doubts about the way BAAN points out a position within the message file. Here are some additional explanations:

As defined in BEMIS V a position within a message file is pointed out using two semikolons.

To draw an example: "SAX";...;Position;...;"SAX_END"

If an position in a BEMIS V Message File is not taken by a value (this means the position is empty), the position is pointed out as shown above. Moreover the BAAN EDI Module distinguishes between numerical and alphanumerical data format. If a position defined as numerical is empty the position is pointed out using semikolons. On the other hand empty alphanumerical positions are exported in two way. The first way is to point out a position using the semicolons. The second way BAAN exports empty alphanumerical positions is to write two inverted commands within the position. This depends whether the alphanumerical field exists in BAAN's database or not.

Finally we take a look at the following example:

empty numerical Position:

"SAX";...;;...;"SAX_END"

empty alphanumerical Position:

"SAX";...;;...;"SAX_END"

or

"SAX";...;"";...;"SAX_END"

What is new in comparison to BEMIS for BAAN IV

1. The Overhead has been changed. Please look Chapter 2 for more details.
2. Furthermore the positions of the rest of the data records has been restructured.
3. Comming with BEMIS V we have to introduce a new date / time format. The new date format consists of at maximum 14 digits as shown here.

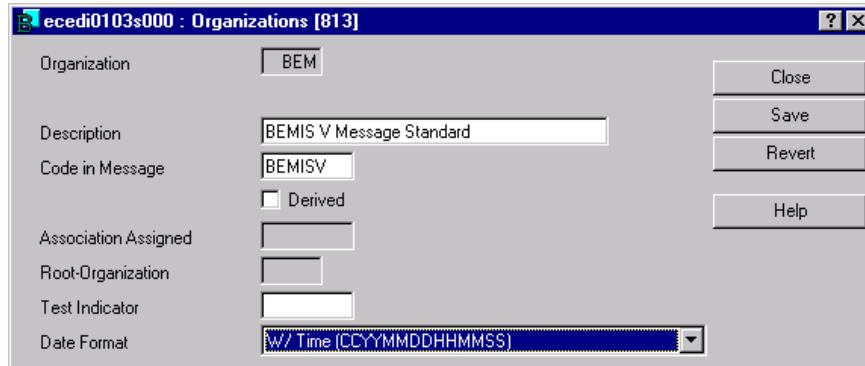

The screenshot shows a dialog box titled "ecedi0103s000 : Organizations [813]". It contains the following fields and controls:

- Organization: BEM
- Description: BEMIS V Message Standard
- Code in Message: BEMISV
- Derived:
- Association Assigned: [Empty]
- Root-Organization: [Empty]
- Test Indicator: [Empty]
- Date Format: w/ Time (CCYYMMDDHHMMSS)

Buttons on the right side: Close, Save, Revert, Help.

The new format is now: CCYYMMDDHHMMSS. The date / time information is put as an numerical field to the position within the message.

4. Comming with BEMIS V, we introduce a new message naming and versioning:

a) Each message type is named by abbreviation and its version number.

To draw an example:

ORD001

Message Type:

ORD for ORDERS

Version: 1

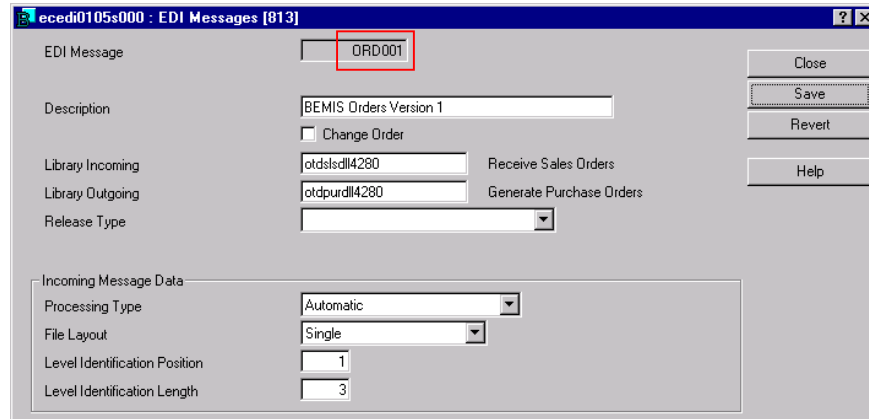

b) It is possibel to define different releases to one message, e.g. Release A, B,... a.s.o.

Example: To draw an example:

ORD001A



Release

Definition of BEMIS V ORD001A Import and Export File for the Message Trading Orders

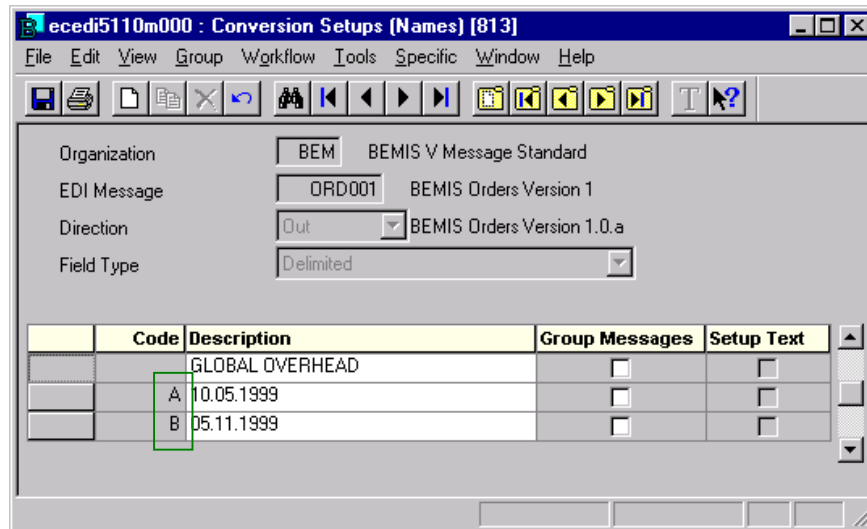

In case of adding new positions to message type a new version will be released.

We have the aim that the BEMIS V Message standard fits to needs of external and internal EDI. Hence we decided to deliver two different conversion setups for one release. One for external EDI and one for internal EDI. The conversion setup for internal EDI gets additionally the extension "I". The structure is the same. For the internal EDI a conversion is only for the business partner codes necessary. Therefore the setup for the internal EDI has a minimum of conversions. It is also possible to use the internal setup for external EDI and the other way around if additionally conversion is needed or not.

To draw an example:

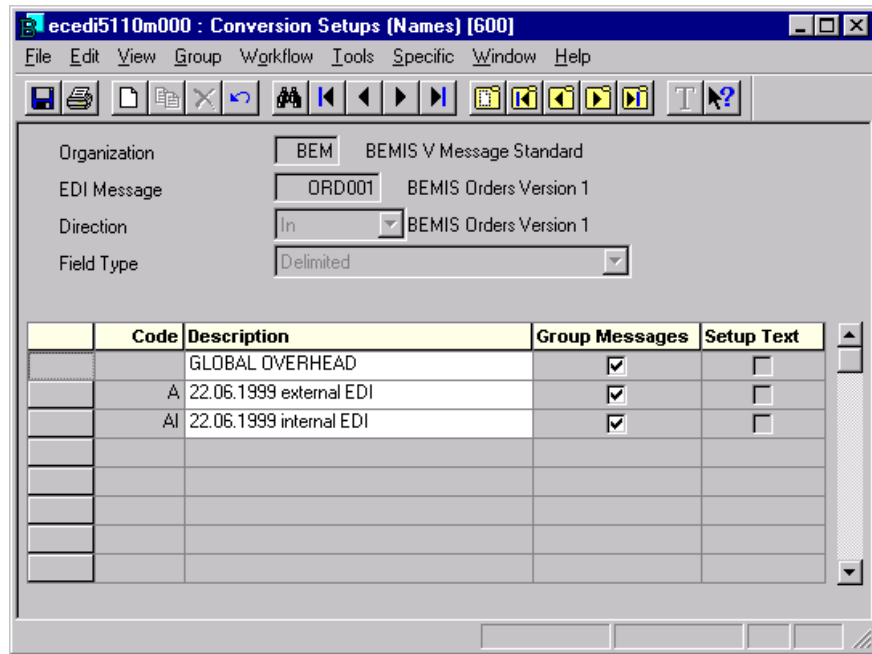
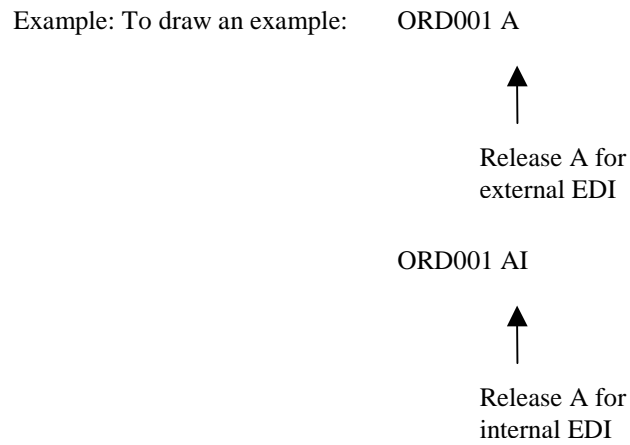

5. Incoming and outgoing messages have now the same file name.

Definition of BEMIS V ORD001A Import and Export File for the Message Trading Orders
1-12

- 6. The name of the message file is now depended from the message version.
- 7. Alternative Items / Item Code Systems

In comparison to BAAN IV the conversion of the Item Codes (customer's item code) has been changed.

BEMIS V comes with two predefined qualifiers in order to determine the internal item code. The Item Code Id's are used in order to distinguish between a general item conversion and a conversion which is business partner related.

Therefore two Codes for the Item System are defined.

Looking at BAAN ERP Common data we will find the used table to translate the item codes:

a) General Code System:

Code in Message	Description	Item Code System
SA	Std. BP BEMIS Item Code ID	BE2
ZZ	Std General BEMIS Item Code ID	BE1

b) Business Partner specific Code System:

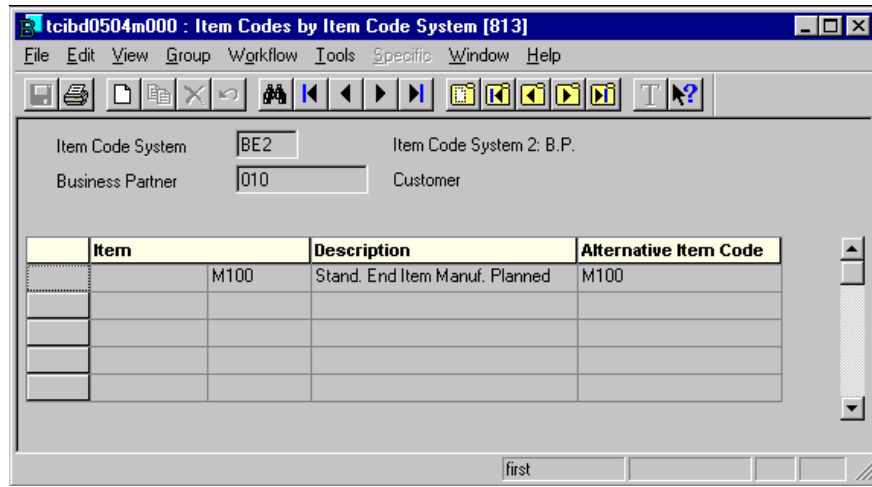

The exported BAAN ERP Item Code is a string with at maximum 47 digists. At minimum the item code contains 10 digits. To draw anexample: “.....1” (nine leading blanks and at minimum one sign).

2 Data record description by kind of data record

SA1 MESSAGE OVERHEAD

Status: Mandatory
 Frequency: Once by order
 Description: This data record contains information about the transmitter, the message type and the time of the transmission. The message reference identifies all related data records of this message.

<i>ORDER INHOUSE FORMAT</i>					<i>Mapping from Application Table Fields (out)</i>		<i>Mapping to Application Fields (in)</i>	
<i>Pos</i>	<i>FIELD DESCRIPTION</i>	<i>Key</i>	<i>ST</i>	<i>FM</i>	<i>Table Field</i>	<i>Action</i>	<i>Table Field</i>	<i>Action</i>
1.	Kind of data record	O/I	M	an3	SA1		SA1	
2.	Message reference	O/I	M	an..14	ecedi701.bano	Generation (see below)	ecedi702.bano	Generation by EDI Sub-System
3.	Identification of the Sender	O/I	M	an..17	ecedi020.neta	Conversion (see below)	ecedi702.bpid	Conversion (see below)
4.	Identification of the Reciever		M	an..17	ecedi028.neta	Conversion (see below)		
5.	Message		M	an..6	ecedi001.code	Conversion (see below)	ecedi702.mess	Conversion (see below)
6.	Organization		M	an..6	ecedi003.code	Conversion (see below)	ecedi702.orga	Conversion (see below)
7.	Order type		M	an..35	ecedi011.koor	Conversion (see below)	ecedi702.koor	Conversion (see below)

Definition of BEMIS V ORD001A Import and Export File for the Message Trading Orders

Data record **description by kind of data record**

<i>ORDER INHOUSE FORMAT</i>					<i>Mapping from Application Table Fields (out)</i>		<i>Mapping to Application Fields (in)</i>	
<i>Pos</i>	<i>FIELD DESCRIPTION</i>	<i>Key</i>	<i>ST</i>	<i>FM</i>	<i>Table Field</i>	<i>Action</i>	<i>Table Field</i>	<i>Action</i>
8.	Transmission reference		M	an..20	tdpur400.orno		ecedi702.msno	
9.	Date / Time of transmission		M	n..14	current date / time		ecedi702.send	
10.	Transmission reference old		C	an..20	empty position (...;...)		ecedi702.pno	
11.	Identification of the technical message creator		C	an..35	"BAANERP"			
12.	Identifier of Test Messages		C	an1	ecedi003.test	empty means original message; 1 means Test message	ecedi702.test	empty means original message; 1 means Test message
13.	Message Funktion		C		empty, not supported for outgoing messages		leave the position empty this means: ...;;... (ecedi702.mest)	
14.	Data record end sign		M	an7	SA1_END		SA1_END	

Detailed description:	Order
Kind of data record:	SA1 Overhead

Position	1	Field format	an3	Field status	M
Field name	Kind of data record		(Key field out/in)		

Description: This field identifies the kind of data record in the message block. It contains the constant value 'SA1'.

Processing outgoing

EDI Sub-System:

.

BAAN:

This field will be filled with the constant value 'SA1'.

Processing incoming

EDI Sub-System:

This field will be filled with the constant value 'SA1'.

BAAN:

None

Position	2	Field format	an..14	Field status	M
Field name		Message reference		(Key field out/in)	

Description: This field identifies all connected data records of one order. The numbering, which has to be clear by order, helps to control the chronological order of the orders and the complete transmission. The field consists of a fix item with four characters, the current date (format: YYMMDD) and a serial number with four characters.

The special format will be defined in the network parameters in the BAAN table TBecedi020. When generating the message reference with the EDI Sub-System, the created message reference needs to be specific, that means unique. While storing the message reference BAAN controls whether it is specific.

Processing outgoing

EDI Sub-System:

BAAN:

BAAN generates this number to identify an order, stores it in the BAAN table field TFecedi701.bano and writes it into all data records of an order.

Processing incoming

EDI Sub-System:

The EDI Sub-System generates this number to identify an order and writes it into all data records of an order.

BAAN:

Mapping to BAAN table field TFecedi702.bano.

Position 3	Field format	an..17	Field status	M
Field name	Identification of the sender		(Key field out/in)	

Description: This field contains the identification of the sender (e.g. the ILN Number)

Processing outgoing

EDI Sub-System: Transmission of the value from the message file.

BAAN: The identification is stored in the BAAN table TBecedi020 'Our Identification' under the corresponding network in the BAAN table field TFecedi020.neta. The contents of this field is mapped to the position of the transmission file. Here you can store the general ILN-Number for your customer.

Processing incoming

EDI Sub-System:

BAAN: The identification of the sender determines the corresponding business partner (customer) and the network in the table TBecedi028 'Relations by network'. This identification is mapped to the BAAN table field TFecedi702.bpid.

Position	4	Field format	an..17	Field status	M
Field name	Identification of the receiver				

Description: This field contains the identification of the receiver.

Processing outgoing

EDI Sub-System:

BAAN: The identification of the receiver (e.g. the ILN of the receiver) in the used network is entered in the table TBecedi028. The BAAN table field TFecedi028.neta is mapped to this position.

Processing incoming

EDI Sub-System: Transmission of the value from the message file.

BAAN: On the incoming side this field will be ignored.

Position	5	Field format	an..6	Field status	M
Field name	Message				

Description: This field contains the code for the identification of the concerned message. The code for the message type 'Orders' is ORD001.

Processing outgoing

EDI Sub-System:

BAAN: The internal message code ecedi001.code 'ORD001' of the BAAN table TBecedi001 'Supported EDI messages' is mapped to this position.

Processing incoming

EDI Sub-System:

This field will be filled with the constant value 'ORD001'.

BAAN:

The message code in the table TBecedi001 'Supported EDI Messages' determines, which internal message in BAAN is connected to this order. In the BAAN table TBecedi005 'EDI Messages' is determined for every message which session (DII) is used in BAAN to process the order. The message code is mapped to the BAAN table field TFecedi702.mess.

Position	6	Field format	an..6	Field status	M
Field name	Organization				

Description: This field contains the organization (Standard), which is used for the EDI communication.

Processing outgoing

EDI Sub-System:

BAAN: The internal organisation code ecedi003.code 'BEMISV' from the BAAN table TBecedi003 'Organizations' is mapped to this position.

Processing incoming

EDI Sub-System:

This field will be filled with the constant value 'BEMISV'.

BAAN:

Mapping to BAAN table field TFecedi702.orga.
The corresponding organization must have been entered into the BAAN table TBecedi003.

Position	7	Field format	an..35	Field status	M
Field name	Order type				

Description: This field contains a code for the concerned order type.

Processing outgoing

EDI Sub-System:

BAAN: In the BAAN table TBecedi011 there must be an entry for this order type in connection with the respective message and organization. The BAAN table field TFecedi011.koor is mapped to this position. This field is filled with the EDIFACT order types. For example "220" for normal orders. The inhouse order type is converted in TBecedi433.

Processing incoming

EDI Sub-System:

BAAN: Mapping to BAAN table field TFecedi702.koor.
In the BAAN table TBecedi200 there must be an entry for this order type in connection with the respective message and organization.

Position	8	Field format	an..20	Field status	M
Field name	Transmission Reference				

Description: This field contains the reference code which the EDI Sub-System applied to this transmission.

Processing outgoing

EDI Sub-System:

BAAN: The position will be filled with the purchase order number from BAAN table field TFtdpur400.orno

Processing incoming

EDI Sub-System: Transmission of the value from the transmission file.

BAAN: Mapping to BAAN table field TFecedi702.msno. This field should contain the customer purchase order number.

Position	9	Field format	n..14	Field status	M
Field name	Date / Time of transmission				

Description: This field contains on the outgoing side the current date / time, on which the order message was created. On the incoming side, this field contains the arrival date / time of the order at the EDI Sub-System (format: YYYYMMDDHHMMSS).

Processing outgoing

EDI Sub-System:

BAAN: Mapping of the current date / time to the position.

Processing incoming

EDI Sub-System: Entry of the arrival date / time of the message at the EDI Sub-System.

BAAN: Mapping to BAAN table field TFecedi702.send

Position	10	Field format	an..20	Field status	C
Field name	Transmission reference old				

Description: This field contains the reference number, which the EDI Sub-System applied to the previous transmission.

Processing outgoing

EDI Sub-System:

BAAN: not used

Processing incoming

EDI Sub-System: Transmission of the value from the transmission file.

BAAN: Mapping to BAAN table field TFecedi702.prho.

Position	11	Field format	an..35	Field status	C
Field name	Identification of the technical message creator				

Description: This fields contains an identification of the technical message creator

Processing outgoing

EDI Sub-System:

BAAN: The position will be filled with the constant value 'BAANERP' .

Processing incoming

EDI Sub-System: The EDI Sub System put its identifierer to this position.

BAAN: None.

Position	12	Field format	an..35	Field status	C
Field name	Indentification of Test Messages				

Description: Identification if the message is a test message or an original message.

Processing outgoing

EDI Sub-System: None.

BAAN: This field will be filled with the value of table field TFecedi003.test. Test messages have to be identified with a '1', original messages with an empty field.. This has to be marked in the table TBecedi003.

Processing incoming

EDI Sub-System: Transmission of the value from the transmission file.

BAAN: Test messages are checked but nor entered in the system. There will be a report, if the message is okay or not.

Position	13	Field format	an7	Field status	M
Field name	Data record end sign				

Description: This field indicates the end of the data record. It contains the constant value 'SA1_END'.

Processing outgoing

EDI Sub-System:

BAAN: This field will be filled with the constant value 'SA1_END'.

Processing incoming

EDI Sub-System: This field will be filled with the constant value 'SA1_END'.

BAAN: None

SA2 ORDER HEADER

Status : Mandatory

Frequency: Once by order number

Description: This data record contains all information of the order header except of address and text data and is related to SA1.

ORDER INHOUSE FORMAT					Mapping from Application Table Fields (out)		Mapping to Application Fields (in)	
Pos	FIELD DESCRIPTION	Key	ST	FM	Table Field	Action	Table Field	Action
1.	Kind of data record	O/I	M	an3	SA2		SA2	
2.	Message reference	O/I	M	an..14	ecedi701.bano		ecedi702.bano	
3.	Identification of the sender	O/I	M	an..17	ecedi020.neta	Conversion	tdsls400.ofbp	Conversion (see below)
4.	Customer Order Number	O/I	M	an..9 an..30	tdpur400.orno		tdsls400.corn	
5.	Contract Number		C	an..9	tdpur400.pno	Code und Conversion	tdsls400.pno	Code und Conversion
6.	Order Date / Time		C	n..14	tdpur400.odat		tdsls400.odat	
7.	Delivery Date / Time		C	n..14	tdpur400.ddat or tdpur400.ddtc	EDI Expression ORD1	tdsls400.ddat	
8.	Term of Delivery		C	an..6	tdpur400.cdec	Code and Conversion	tdsls400.cdec	Code and Conversion
9.	Terms of Payment		C	an..6	tdpur400.cpay	Code and Conversion	tdsls400.cpay	Code and Conversion
10.	Order Discount		C	n..6	tdpur400.odis	NNN.NN	tdsls400.odis	NNN.NN
11.	Currency		C	an..6	tdpur400.ccur	Code and Conversion	tdsls400.ccur	Code and Conversion
12.	Purchase / Sales Currency Rate		C	n..13	tdpur400.ratp (1)	NNNNNN.NNN NNN		
13.	Purchase Rate Factor		C	n..6	tdpur400.ratf (1)	NNNNNN		
14.	Late Payment Surcharge		C	n..6	tdpur400.ccrs	Code and Conversion	tdsls400.ccrs	Code and Conversion
15.	Forwarding Agent		C	an..20	tdpur400.cfrw	Code and Conversion	tdsls040.cfrw	Code and Conversion

Data record **description by kind of data record**

ORDER INHOUSE FORMAT					Mapping from Application Table Fields (out)		Mapping to Application Fields (in)	
Pos	FIELD DESCRIPTION	Key	ST	FM	Table Field	Action	Table Field	Action
16.	Reference A		C	an..30	tdpur400.refa		tdsls400.refa	
17.	Reference B		C	an..20	tdpur400.refb		tdsls400.refb	
18.	Qualifier Address Code		M	an2	ZZ		ZZ	
19.	Purchase Price List		C	an..3	tdpur400.cplp		tdsls400.cpls	
20.	Region		C	an..3	tdpur400.creg		tdsls400.creg	
21.	Line of Business		C	an..6	tdpur400.cbrn		tdsls400.cbrn	
22.	Planned receipt date / time		C	n..14			tdsls400.prdt	
23.	Description Terms of Delivery		C	an..30	tcms041.dsca			
24.	Description of the Carrier		C	an..30	tcms080.dsca			
25.	Description Late Payment Surcharges		C	an..30	tcms011.dsca			
26.	Description Terms Of Payment		C	an..30	tcms013.dsca			
27.	Country		C	an..3	tdpur400.ccty		tdsls400.ccty	
28.	Self Billed Invoice		C	an1	tdpur400.sbim	0 means empty position 1 means yes 2 means no	tdsls400.sbim	
29.	Purchase Office		C	an..6	tdpur400.cofc	Code and Conversion		
30.	Buy From Business Partner		C	an..20	tdpur400.otbp	Code and Conversion		
31.	Qualifier Address / Partner Code Buy From		C	an4	ecedi224.code		“BFBP”	
32.	Ship From Business Partner		C	an..20	tdpur400.sfbp	Code and Conversion	tdsls400.cwar	Code and Conversion
33.	Qualifier Address / Partner Code Ship From		C	an4	ecedi224.code		“SFBP”	
34.	Invoice From Business Partner		C	an..20	tdpur400.ifbp	Code and Conversion		

Definition of BEMIS V ORD001A Import and Export File for the Message Trading Orders

<i>ORDER INHOUSE FORMAT</i>					<i>Mapping from Application Table Fields (out)</i>		<i>Mapping to Application Fields (in)</i>	
<i>Pos</i>	<i>FIELD DESCRIPTION</i>	<i>Key</i>	<i>ST</i>	<i>FM</i>	<i>Table Field</i>	<i>Action</i>	<i>Table Field</i>	<i>Action</i>
35.	Qualifier Address / Partner Code Invoice From		C	an4	ecedi224.code		"IFBP"	
36.	Pay To Business Partner		C	an..20	tdpur400.ptbp	Code and Conversion		
37.	Qualifier Address / Partner Code pay To		C	an4	ecedi224.code		"PTBP"	
38.	Code for the Warehouse		C	an..20	tdpur400.cwar	Code and Conversion	tdsls040.stbp	Code and Conversion
39.	Qualifier Address / Partner Code Warehouse		C	an4	ecedi224.code		"CWAR"	
40.	Remittance Agreement		C	an..16	tdpur400.ragr			
41.	Fixed Rate		C	an..1	tdpur400.mcfr	0 = empty 1 = fixed local 2 = fixed hard 3 = fixed local and hard 4 = Delivery Date 5 = Document Date 6 = expected Cash Date 7 = Manually Entered		
42.	Route Plan		C	an..3	tdpur400.ctrj			
43.	Original Order Typ		C	n1	tdpur400.odty	0 means empty 1 means order 2 means receipt		
44.	Original Order Number		C	an..9	tdpur400.odno			
45.	Invoice to Business Partner		C	an..20			tdsls400.itbp	Code –and Conversion
46.	Pay By Business Partner		C	an..20			tdsls400.pfbp	Code –and Conversion

ORDER INHOUSE FORMAT					<i>Mapping from Application Table Fields (out)</i>		<i>Mapping to Application Fields (in)</i>	
<i>Pos</i>	<i>FIELD DESCRIPTION</i>	<i>Key</i>	<i>ST</i>	<i>FM</i>	<i>Table Field</i>	<i>Action</i>	<i>Table Field</i>	<i>Action</i>
47.	Qualifier Sold To Business Partner		M	an4	“STBP”		“STBP”	
48.	Qualifier Ship To Business Partner		M	an4	“SIBP”		“SIBP”	
49.	Qualifier Invoice To Business Partner		M	an4	“ITBP”		“ITBP”	
50.	Qualifier Pay By Business Partner		M	an4	“PBBP”		“PBBP”	
51.	Warehouse Address Code			an..9	tdpur400.cadr			
52.	Data record end sign		M	an7	SA2_END		SA2_END	

EDI-Expression:

ORD1: tdpur400.ddtc <> 0

Detailed description:	Order
Kind of data record:	SA2 Order Header

Position	1	Field format	an3	Field status	M
Field name		Kind of data record		(Key field out/in)	

Description: This field identifies the kind of data record in the message block. It contains the constant value ‘SA2’.

Processing outgoing

EDI Sub-System:

BAAN: This field will be filled with the constant value ‘SA2’.

Processing incoming

EDI Sub-System: This field will be filled with the constant value ‘SA2’.

BAAN:

Position	2	Field format	an..14	Field status	M
Field name	Message reference		(Key field out/in)		

Description: This field identifies all connected data records of one order. The numbering of the message reference, which has to be clear by Order, helps to control the chronological order of the Orders and the complete transmission.

Processing outgoing

EDI Sub-System:

BAAN: Refer to data record SA1.

Processing incoming

EDI Sub-System: Refer to data record SA1

BAAN:

Position	3	Field format	an..17	Field status	M
Field name	Identification of the sender		(Key field out)		

Description: This field contains the identification of the sender.

Processing outgoing

EDI Sub-System:

BAAN: Refer to data record SA1

Processing outgoing

EDI Sub-System:

BAAN: Refer to data record SA1

Refer to data record SA1

Position	4	Field format	out an..9 / in an..30	Field status	M
Field name	Order Number			(Key field in/out)	

Description: This field contains the order number.

Processing outgoing

EDI Sub-System: None.

BAAN: The purchase order number is mapped from BAAN table field TFtdpur400.orno to this position.

Processing incoming

EDI Sub-System: Transmission of the value from the message file.

BAAN: Mapping to BAAN table field TFtdsls400.corn

Position	5	Field format	an..9	Field status	C
Field name	Contract Number				

Description: This field contains the Contract Number which is defined with the business partner. A Conversion is possible.

Processing outgoing

EDI Sub-System: None

BAAN: The purchase contract number is mapped from BAAN table TBtdpur400.prho to this position after conversion with BAAN table TBecedi453.

Processing incoming

EDI Sub-System: Transmission of the value from the message file.

BAAN: Mapping to the BAAN table field TFtdsls400.prho after conversion with BAAN table TBecedi314.

Position	6	Field format	n..14	Field status	C
Field name	Order Date / Time				

Description: This field contains the date / time (YYYYMMDDHHMMSS) the order is entered in the system.

Processing outgoing

EDI Sub-System: None.

BAAN: The order date / time from BAAN table field TFtdpur400.odat is mapped to this position.

Processing incoming

EDI Sub-System: Transmission of the value from the message file or entry of the arrival date / time of the message at the EDI Sub-System (only possible, if the delivery date / time is not in the past)

BAAN: Mapping to BAAN table field TFtdsls400.odat

Position	7	Field format	n..14	Field status	C
Field name	Delivery Date / Time				

Description: This field contains the date / time (YYYYMMDDHHMMSS) on which the delivery should take place.

Processing outgoing

EDI Sub-System: None.

BAAN: The purchase order delivery date / time from BAAN table field TFtdpur400.ddat is mapped to this position.

Processing incoming

EDI Sub-System: Transmission of the value from the message file.

BAAN: Mapping to the BAAN table field TFtdsls400.ddat.

Position	8	Field format	an..6	Field status	C
Field name	Term of Delivery				

Description: This field contains a code for the Term of Delivery. This field indicates how to frank the shipment (unfranked,...) It contains a unique alphanumeric identification.

01 = unfranked (unfrei)
 02 = free destination (frei Bestimmungsort)
 03 = free to the door (frei Haus)
 04 = free German border (frei deutsche Grenze)
 05 = free receiving carrier (frei Empfängsspediteur)
 99 = special postage (Sonderfrankatur)

Processing outgoing

EDI Sub-System: None.

BAAN: The Term of Delivery of the purchase order from BAAN table field TFtdpur400.cdec is mapped to this position. If other definitions are used in BAAN, the BAAN table TBecedi430 is used for conversion.

Processing incoming

EDI Sub-System: Transmission of the value from the message file.

BAAN: Mapping to the BAAN table field TFtdsls400.cdec and conversion via BAAN table TBecedi300.

Position	9	Field format	an..6	Field status	C
Field name	Terms of Payment				

Description: This field contains a Code for the Terms of Payment agreed upon with the relation.

Processing outgoing

EDI Sub-System:

BAAN: The Terms of Delivery of the purchase order from BAAN table field TFtdpur400.cpay is mapped to this position and converted using the table TBecedi466.

Processing incoming

EDI Sub-System: Transmission of the value from the message file.

BAAN: Mapping to the BAAN table field TFtdsls400.cpay and conversion via BAAN table TBecedi326.

Position	10	Field format	n..6	Field status	C
Field name	Order Discount				

Description: This field contains the Order Discount related to the complete order amount.
NNN.NN. Maximum is 100.00

Processing outgoing

EDI Sub-System:

BAAN: The Order Discount of the purchase order from BAAN table field TFtdpur400.odis is mapped to this position.

Processing incoming

EDI Sub-System: Transmission of the value from the message file.

BAAN: Mapping to the BAAN table field TFtdsls400.odis

Position	11	Field format	an..6	Field status	C
Field name	Currency				

Description: This field contains the Currency relevant for the order. It contains the clear alphanumerical identification of the currency. The currency code will be defined according to ISO 4217, e.g., 280 for German mark (DM). For detailed information please refer to the BEMIS V Cookbook (U7315AUS).

Processing outgoing

EDI Sub-System:

BAAN:

The Currency relevant for the purchase order from BAAN table field TFtdpur400.ccur is mapped to this position and converted using table TBecedi438.

Processing incoming

EDI Sub-System:

Transmission of the value from the message file.

BAAN:

Mapping to the BAAN table field TFtdsls400.ccur and conversion with BAAN table TBecedi324.

Position	12	Field format	n..13	Field status	C
Field name	Purchase / Sales Currency Rate 1				

Description: This field contains the Rate used to convert the currency (position 1) into the home currency.

Processing outgoing

EDI Sub-System:

BAAN: The currency rate of the purchase order from BAAN table field TFtpur400.ratp is mapped to this position.

Processing incoming

EDI Sub-System:

BAAN: None

Position	13	Field format	n..6	Field status	C
Field name	Purchase Rate Factor 1				

Description: This field contains the Rate Factor used as basis for the conversion of the currency. Mostly used 1, 10, 100 or 1000.

Processing outgoing

EDI Sub-System:

BAAN: The rate factor of the purchase order from BAAN table field TFtdpur400.ratf is mapped to this position.

Processing incoming

EDI Sub-System:

BAAN: None

Position	14	Field format	n..3	Field status	C
Field name	Late Payment Surcharge				

Description: This field contains the Late Payment Surcharge agreed upon with the relation.

Processing outgoing

EDI Sub-System:

BAAN: The Late Payment Surcharge of the purchase order from BAAN table field TFtdpur400.ccrs is mapped to this position. A conversion has to be done with BAAN table TBecedi470.

Processing incoming

EDI Sub-System: Transmission of the value from the message file.

BAAN: Mapping to the BAAN table field TFtdsls400.ccrs and conversion with BAAN table TBecedi330.

Position	15	Field format	an..20	Field status	C
Field name	Forwarding Agent				

Description: This field contains the Code of the Forwarding Agent used for this order. The code list has to be agreed with the partner.

Processing outgoing

EDI Sub-System:

BAAN: The Code for the Forwarding Agent of the purchase order from BAAN table field TFtdpur400.cfrw is mapped to this position and converted with BAAN table TBecedi456.

Processing incoming

EDI Sub-System: Transmission of the value from the message file.

BAAN: Mapping to the BAAN table field TFtdsls400.cfrw and conversion with BAAN table Tbecedi318.

Position	16	Field format	an..30	Field status	C
Field name	Reference A				

Description: This field contains a reference. You can use this field to give further information to your supplier.

Processing outgoing

EDI Sub-System:

BAAN: The Reference A of the purchase order from BAAN table field TFtdpur400.refa is mapped to this position.

Processing incoming

EDI Sub-System: Transmission of the value from the message file.

BAAN: Mapping to the BAAN table field TFtdsls400.refa.

Position	17	Field format	an..20	Field status	C
Field name	Reference B				

Description: This field contains a second reference field for further information defined with the relation.

Processing outgoing

EDI Sub-System:

BAAN: The Reference B of the purchase order from BAAN table field TFtdpur400.refb is mapped to this position.

Processing incoming

EDI Sub-System: Transmission of the value from the message file.

BAAN: Mapping to the BAAN table field TFtdsls400.refb.

Position	18	Field format	an2	Field status	M
Field name	Qualifier Address Code				

Description: This field contains the first Qualifier for the Delivery Address Code.

Processing outgoing

EDI Sub-System:

BAAN: The field is filled with the constant value 'ZZ'.

Processing incoming

EDI Sub-System: This field is filled with the constant value 'ZZ'.

BAAN:

Position	19	Field format	an..3	Field status	M
Field name	Purchase/Sales Price List				

Description: The price list code used for the order. The code has to be agreed upon with the relation.

Processing outgoing

EDI Sub-System:

BAAN: The code for the Purchase Price List from BAAN table field TFtdpur400.cplp is mapped to this position.

Processing incoming

EDI Sub-System: Transmission of the value from the message file.

BAAN: Mapping to the BAAN table field TFtdsls400.cplp.

Position	20	Field format	an..3	Field status	M
Field name	Region				

Description: This field contains the Region the customer/supplier belongs to. The Code must be mutual defined with the customer/supplier. A conversion is not possible.

Processing outgoing

EDI Sub-System:

BAAN: The Region code from BAAN table field TFtdpur400.creg is mapped to this position.

Processing incoming

EDI Sub-System: Transmission of the value from the message file.

BAAN: Mapping to the BAAN table field TFtdsls400.creg.

Position	21	Field format	an..3	Field status	M
Field name	Line of Business				

Description: This field contains the Code for the Line of Business the customer/supplier belongs to. The Code must be mutual defined with the customer/supplier. A conversion is not possible.

Processing outgoing

EDI Sub-System:

BAAN: The code for the line of business from BAAN table field TFtdpur400.cbrn is mapped to this position.

Processing incoming

EDI Sub-System: Transmission of the value from the message file.

BAAN: Mapping to the BAAN table field TFtdsls400.cbrn

Position	22	Field format	n..14	Field status	C
Field name	Planned receipt date / time				

Description: This field contains the date and the time information in refer to the planned date/time when the goods will be receipt. Please refer to the remarks concerning the new date / time format for BAAN ERP above.

Processing outgoing

EDI Sub-System:

BAAN:

Processing incoming

EDI Sub-System: Transmission of the value from the message file or the same date as filled on position 7.

BAAN: Mapping to the BAAN table field TFtdsls400.prdt.

Position	23	Field format	an..30	Field status	C
Field name	Description Terms of Delivery				

Description: This field contains the description of the Terms Delivery Code in position SA2.8.

Processing outgoing

EDI Sub-System:

BAAN: The description for the code of the terms of delivery from BAAN table field TFtcmcs041.dsca is mapped to this position.

Processing incoming

EDI Sub-System:

BAAN: None.

Position	24	Field format	an..30	Field status	C
Field name	Description of the Carrier				

Description: This field contains the description of the party who carries the goods.

Processing outgoing

EDI Sub-System:

BAAN: The description of the carrier from BAAN table field TFtcmcs080.dsca is mapped to this position.

Processing incoming

EDI Sub-System:

BAAN: None.

Position	25	Field format	an..30	Field status	C
Field name	Description Late Payment Surcharges				

Description: This field contains the description of the code of the late payment surcharges in position SA2.14.

Processing outgoing

EDI Sub-System:

BAAN: The description of the code of the late payment surcharges from BAAN table field TFtcmcs011.dsca is mapped to this position.

Processing incoming

EDI Sub-System:

BAAN: None.

Position	26	Field format	an..30	Field status	C
Field name	Description Terms of Payment				

Description: This field contains the description of the Code for the Terms of payment in position SA2.9.

Processing outgoing

EDI Sub-System:

BAAN: The description of the Code for the Terms of Payment from BAAN table field TFtdpur400.dsca is mapped to this position.

Processing incoming

EDI Sub-System:

BAAN: None.

Position	27	Field format	an..3	Field status	C
Field name	Country				

Description: This field contains the country code.

Processing outgoing

EDI Sub-System:

BAAN: The Country Code for the from BAAN table field TFtdpur400.ccty is mapped to this position.

Processing incoming

EDI Sub-System: Transmission of the value from the message file.

BAAN: Mapping to the BAAN table field TFtdsls400.ccty.

Position	28	Field format	an1	Field status	C
Field name	Self Billed Invoice				

Description: This qualifier is used to show whether self billed invoicing is used or not.

used codes:

“0” means empty position

“1” means yes

“2” means no

Processing outgoing

EDI Sub-System:

BAAN: The Code for Self Billed Invoicing from BAAN table field TFtdpur400.sbim is mapped to this position.

Processing incoming

EDI Sub-System:

BAAN: None.

Position	29	Field format	an..6	Field status	C
Field name	Purchase Office				

Description: The code of the purchase office.

Processing outgoing

EDI Sub-System:

BAAN: The Code for Purchase Office from BAAN table field TFtdpur400.cofc is converted using the conversion table ecedi420 and the default qualifier “ZZ” and is mapped to this position.

Processing incoming

EDI Sub-System:

BAAN: None.

Position	30	Field format	an..20	Field status	C
Field name	Buy From Business Partner				

Description: This position contains the code for the Business Partner where the customer buys its goods.

Processing outgoing

EDI Sub-System:

BAAN: The Code for the Buy From Business Partner from BAAN table field Tftdpur400.otbp is converted using the conversion table ecedi468 and Address Code Id "ZZ" and is mapped to this position.

Processing incoming

EDI Sub-System:

BAAN: None.

Position	31	Field format	an4	Field status	C
Field name	Qualifier Address / Partner Code Buy From				

Description: This position contains the standard qualifier for the buy from business partner.

Processing outgoing

EDI Sub-System:

BAAN: The constant "BFBP" is mapped to this position.

Processing incoming

EDI Sub-System:

BAAN: None.

Position	32	Field format	an..20	Field status	C
Field name	Ship From Business Partner				

Description: This position contains the code for the Business Partner who will deliver the goods.

Processing outgoing

EDI Sub-System:

BAAN: The Code for the Ship From Business Partner from BAAN table field TFtdpur400.otbp is converted using the conversion table ecedi468 and Address Code Id "ZZ" and is mapped to this position.

Processing incoming

EDI Sub-System: Transmission of the value from the message file.

BAAN: Mapping to the BAAN table field TFtdsls400.cwar using the code and conversion table ecedi355 and the Address Code Id "ZZ"..

Position	33	Field format	an4	Field status	C
Field name	Qualifier Address / Partner Code Ship From				

Description: This position contains the standard qualifier for the ship from business partner.

Processing outgoing

EDI Sub-System:

BAAN: The constant "SFBP" is mapped to this position.

Processing incoming

EDI Sub-System:

BAAN: None.

Position	34	Field format	an..20	Field status	C
Field name	Invoice From Business Partner				

Description: This position contains the code for the Business Partner who will send the invoice to the customer.

Processing outgoing

EDI Sub-System:

BAAN: The Code for the Invoice From Business Partner from BAAN table field Tftdpur400.ifbp is converted using the conversion table ecedi468 and the Address Code Id "ZZ" and is mapped to this position.

Processing incoming

EDI Sub-System:

BAAN: None.

Position	35	Field format	an4	Field status	C
Field name	Qualifier Address / Partner Code Invoice From				

Description: This position contains the standard qualifier for the invoice from business partner.

Processing outgoing

EDI Sub-System:

BAAN: The constant "IFBP" is mapped to this position.

Processing incoming

EDI Sub-System:

BAAN: None.

Position	36	Field format	an..20	Field status	C
Field name	Pay To Business Partner				

Description: This position contains the code for the Business Partner who will get the money from the customer.

Processing outgoing

EDI Sub-System:

BAAN: The Code for the Pay To Business Partner from BAAN table field Tftdpur400.ptbp is converted using the conversion table ecedi468 and the Address Code Id “ZZ”and is mapped to this position.

Processing incoming

EDI Sub-System:

BAAN: None.

Position	37	Field format	an4	Field status	C
Field name	Qualifier Address / Partner Code Pay To				

Description: This position contains the standard qualifier for the Pay To business partner.

Processing outgoing

EDI Sub-System:

BAAN: The constant “PTBP” is mapped to this position.

Processing incoming

EDI Sub-System:

BAAN: None.

Position	38	Field format	an..20	Field status	C
Field name	Code for the Warehouse				

Description: This position contains the code for the customer's warehouse.

Processing outgoing

EDI Sub-System:

BAAN: The Code for the customer's warehouse from BAAN table field TFtdpur400.cwar is converted using the conversion table ecedi462 and the qualifier "ZZ" and is mapped to this position.

Processing incoming

EDI Sub-System: Transmission of the value from the message file.

BAAN: Mapping to the BAAN table field TFtdsls400.sfbp using the code and conversion table ecedi328 .and the Address Code ID "ZZ".

Position	39	Field format	an4	Field status	C
Field name	Qualifier Address / Partner Code Warehouse				

Description: This position contains the standard qualifier for the ship from business partner.

Processing outgoing

EDI Sub-System:

BAAN: The constant "SFBP" is mapped to this position.

Processing incoming

EDI Sub-System:

BAAN: None.

Position	40	Field format	an..16	Field status	C
Field name	Remittance Agreement				

Description: A subcontracting document that contains agreements about how the payment for a project will take place. For example, the remittance agreement states the part of the invoice amount that must be paid to the subcontractor's industrial assurance board (IAB) and to the tax authorities.

Processing outgoing

EDI Sub-System:

BAAN: The Remittance Agreement number from BAAN table field TFtdpur400.ragr is mapped to this position.

Processing incoming

EDI Sub-System:

BAAN: None.

Position	41	Field format	an1	Field status	C
Field name	Fixed Rate				

Description: The exchange rate agreed upon by contract with your bank or business partner (in order to avoid a currency loss).Used values:

- 0 = empty
- 1 = fixed local
- 2 = fixed hard
- 3 = fixed local and hard
- 4 = Delivery Date
- 5 = Document Date
- 6 = expected Cash Date
- 7 = Manually Entered

Processing outgoing

EDI Sub-System:

BAAN: The Fixed Rate identifier from BAAN table field TFtdpur400.mcf is mapped to this position.

Processing incoming

EDI Sub-System:

BAAN: None.

Position	42	Field format	an..3	Field status	C
Field name	Route Plan				

Description: The code for the Rout Plan which is the code for the line of travel from a warehouses to the ship-to or ship-from business partner's warehouse and vice versa. Use routes to group business partners that are located in the same area or along one convenient route.

Processing outgoing

EDI Sub-System:

BAAN: The Code for Route Plan from BAAN table field TFtdpur400.ctrj is mapped to this position.

Processing incoming

EDI Sub-System:

BAAN: None.

Position	43	Field format	an1	Field status	C
Field name	Original Order Type				

Description: Qualifier to show the origin of the original Order Number: Used values:
 0 means empty
 1 means order
 2 means receipt
 Only used for return orders.

Processing outgoing

EDI Sub-System:

BAAN: The qualifier for the original order type from BAAN table field TFtdpur400.odty is mapped to this position.

Processing incoming

EDI Sub-System:

BAAN: None.

Position	44	Field format	an..16	Field status	C
Field name	Original Order Number				

Description: This position contains the original order number. Only used for return orders.

Processing outgoing

EDI Sub-System:

BAAN: The original order number from BAAN table field TFtdpur400.odno is mapped to this position.

Processing incoming

EDI Sub-System:

BAAN: None.

Position	45	Field format	an..20	Field status	C
Field name	Invoice To Business Partner				

Description: This position contains the code for the receiver of the invoice.

Processing outgoing

EDI Sub-System:

BAAN: None.

Processing incoming

EDI Sub-System: Transmission of the value from the message file.

BAAN: Mapping to the BAAN table field TFtdsls400.itbp using the code and conversion table ecedi328 .and the Address Code Id "ZZ".

Position	46	Field format	an..20	Field status	C
Field name	Pay By Business Partner				

Description: This position contains the code for party which should pay the invoice.

Processing outgoing

EDI Sub-System:

BAAN: None.

Processing incoming

EDI Sub-System: Transmission of the value from the message file.

BAAN: Mapping to the BAAN table field TFtdsls400.pfbp using the code and conversion table ecedi328 .and the Address Code Id "ZZ".

Position	47	Field format	an4	Field status	C
Field name	Qualifier Sold To Business Partner				

Description: This position contains the standard qualifier for the Sold To business partner.

Processing outgoing

EDI Sub-System:

BAAN: The constant "PTBP" is mapped to this position.

Processing incoming

EDI Sub-System: Transmission of the constant value "PTBP" to the message file.

BAAN: None.

Position	48	Field format	an4	Field status	C
Field name	Qualifier Ship To Business Partner				

Description: This position contains the standard qualifier for the Ship To business partner.

Processing outgoing

EDI Sub-System:

BAAN: The constant "SIBP" is mapped to this position.

Processing incoming

EDI Sub-System: Transmission of the constant value "SIBP" to the message file.

BAAN: None.

Position	49	Field format	an4	Field status	C
Field name	Qualifier Invoice To Business Partner				

Description: This position contains the standard qualifier for the Invoice To business partner.

Processing outgoing

EDI Sub-System:

BAAN: The constant "ITBP" is mapped to this position.

Processing incoming

EDI Sub-System: Transmission of the constant value "ITBP" to the message file.

BAAN: None.

Position	50	Field format	an4	Field status	C
Field name	Qualifier Pay By Business Partner				

Description: This position contains the standard qualifier for the Pay By business partner.

Processing outgoing

EDI Sub-System:

BAAN: The constant "PBBP" is mapped to this position.

Processing incoming

EDI Sub-System: Transmission of the constant value "PBBP" to the message file.

BAAN: None.

Position	51	Field format	an..9	Field status	C
Field name	Warehouse Address Code				

Description: This field contains the warehouse code.

Processing outgoing

EDI Sub-System:

BAAN: The warehouse code from BAAN table field TFtdpur400.cwar is mapped to this position after conversion with BAAN table TBecedi462.

Processing incoming

EDI Sub-System:

BAAN: None

Position	52	Field format	an7	Field status	M
Field name	Data record end sign				

Description: This field indicates the end of the data record. It contains the constant value 'SA2_END'.

Processing outgoing

EDI Sub-System:

BAAN: This field will be filled with the constant value 'SA2_END'.

Processing incoming

EDI Sub-System: This field will be filled with the constant value 'SA2_END'.

BAAN: None

SA3 ORDER TEXT - TEXTDATEN

Status : Conditional
 Frequency : Once by order number
 Description: This data record contains the text information of the order header and is related to SA2.

<i>ORDERS) INHOUSE FORMAT</i>					<i>Mapping from Application Table Fields</i>		<i>Mapping to Application Fields</i>	
<i>Pos</i>	<i>FIELD DESCRIPTION</i>	<i>Key</i>	<i>ST</i>	<i>FM</i>	<i>Table Field</i>	<i>Action</i>	<i>Table Field</i>	<i>Action</i>
1.	Kind of data record	O/I	M	an3	SA3		SA3	
2.	Message reference	O/I	M	an..14	ecedi701.bano		ecedi702.bano	
3.	Identification of the sender	O/II	M	an..17	ecedi020.neta	Conversion	tdsls400.ofbp	Conversion (see below)
4.	Order Number	O/I	M	an..9 an..30	tdpur400.orno		tdsls400.com	
5.	Free Header Text 1		C	an..70	tdpur400.txta		tdsls400.txta	
6.	Free Header Text 2		C	an..70	tdpur400.txta		tdsls400.txta	
7.	Free Header Text 3		C	an..70	tdpur400.txta		tdsls400.txta	
8.	Free Header Text 4		C	an..70	tdpur400.txta		tdsls400.txta	
9.	Free Header Text 5		C	an..70	tdpur400.txta		tdsls400.txta	
10.	Data record end sign		M	an7	SA3_END		SA3_END	

Detailed Description:	Order
Kind of data record:	SA3 Order text

Position	1	Field format	an3	Field status	M
Field name		Kind of data record		(Key field out/in)	

Description: This field identifies the kind of data record in the message block. It contains the constant value 'SA3'.

Processing outgoing

EDI Sub-System:

BAAN: This field will be filled with the constant value 'SA3'.

Processing incoming

EDI Sub-System: This field will be filled with the constant value 'SA3'.

BAAN: None

Position	2	Field format	an..14	Field status	M
Field name		Message reference		(Key field out/in)	

Description: This field identifies all connected data records of one Order. The numbering of the message reference, which has to be clear by Order, helps to control the chronological order of the Orders and the complete transmission.

Processing outgoing

EDI Sub-System:

BAAN: Refer to data record SA2.

Processing incoming

EDI Sub-System: Refer to data record SA2.

BAAN: Refer to data record SA2.

Position	3	Field format	an..17	Field status	M
Field name	Identification of the sender (Key field out/in)				

Description: This field contains the identification of the sender.

Processing outgoing

EDI Sub-System: Refer to data record SA2.

BAAN: Refer to data record SA2.

Processing incoming

EDI Sub-System: Refer to data record SA2.

BAAN: Refer to data record SA2.

Position	4	Field format	out an..9 / in an..30	Field status	M
Field name	Order Number		(Key field in/out)		

Description: This field contains the order number.

Processing outgoing

EDI Sub-System:

BAAN: The order number of the purchase order from BAAN table field TFtdpur400.orno is mapped to this position.

Processing incoming

EDI Sub-System: Transmission of the value from the message file.

BAAN: Mapping to BAAN table field TFtdsls400.corn.

Position	5	Field format	an..70	Field status	C
Field name	Free text 1				

Description: This field contains a free text with a maximum of 70 characters.

Processing outgoing

EDI Sub-System:

BAAN: Mapping of BAAN table field TFtdpur400.txta to position.

Processing incoming

EDI Sub-System: Transmission of the value from the transmission file.

BAAN: Mapping to BAAN table field TFtdsls400.txta

Position	6	Field format	an..70	Field status	C
Field name	Free text 2				

Description: This field contains a free text with a maximum of 70 characters.

Processing outgoing

EDI Sub-System:

BAAN: Mapping of BAAN table field TFtdpur400.txta to position.

Processing incoming

EDI Sub-System: Transmission of the value from the transmission file.

BAAN: Mapping to BAAN table field TFtdsls400.txta

Position	7	Field format	an..70	Field status	C
Field name	Free text 3				

Description: This field contains a free text with a maximum of 70 characters.

Processing outgoing

EDI Sub-System:

BAAN: Mapping of BAAN table field TFtdpur400.txta to position.

Processing incoming

EDI Sub-System: Transmission of the value from the transmission file.

BAAN: Mapping to BAAN table field TFtdsls400.txta

Position	8	Field format	an..70	Field status	C
Field name	Free text 4				

Description: This field contains a free text with a maximum of 70 characters.

Processing outgoing

EDI Sub-System:

BAAN: Mapping of BAAN table field TFtdpur400.txta to position.

Processing incoming

EDI Sub-System: Transmission of the value from the transmission file.

BAAN: Mapping to BAAN table field TFtdsls400.txta

Position	9	Field format	an..70	Field status	C
Field name	Free text 5				

Description: This field contains a free text with a maximum of 70 characters.

Processing outgoing

EDI Sub-System:

BAAN: Mapping of BAAN table field TFtdpur400.txta to position.

Processing incoming

EDI Sub-System: Transmission of the value from the transmission file.

BAAN: Mapping to BAAN table field TFtdsls400.txta

Position	10	Field format	an7	Field status	M
Field name	Data record end sign				

Description: This field indicates the end of the data record. It contains the constant value 'SA3_END'.

Processing outgoing

EDI Sub-System:

BAAN: This field will be filled with the constant value 'SA3_END'.

Processing incoming

EDI Sub-System: This field will be filled with the constant value 'SA3_END'.

BAAN: None

SA4 Order Specific Addresses

Status : Conditional
 Frequency : Twice at maximum by order number
 Description: This data record contains the specific addresses of the order header and is related to SA2.

First Appearance: Ship From Business Partner Address (Address Qualifier: SFBP)

<i>ORDER INHOUSE FORMAT</i>					<i>Mapping from Application Table Fields</i>		<i>Mapping to Application Fields</i>	
<i>Pos</i>	<i>FIELD DESCRIPTION</i>	<i>Key</i>	<i>ST</i>	<i>FM</i>	<i>Table Field</i>	<i>Action</i>	<i>Table Field</i>	<i>Action</i>
1.	Kind of data record	O/I	M	an3	SA4		SA4	
2.	Message reference	O/I	M	an..14	ecedi701.bano		ecedi702.bano	
3.	Identification of the sender)	O/II	M	an..17	ecedi020.neta	Conversion	tdsls400.ofbp	Conversion
4.	Order Number	O/I	M	n..9 an..30	tdpur400.orno		tdsls400.corn	
5.	Address Qualifier Ship From Business Partner Address		M	an4	"SFBP"		"SFBP"	Code and Conversion
6.	Ship From Business Partner Address Country		C	an..6	tccom130.ccty	ORD3	tccom130.ccty	Code and Conversion
7.	Ship From Business Partner Address first part of the name		C	an..35	tccom130.nama	ORD3	tccom130.nama	

Data record **description by kind of data record**

<i>ORDER INHOUSE FORMAT</i>					<i>Mapping from Application Table Fields</i>		<i>Mapping to Application Fields</i>	
<i>Pos</i>	<i>FIELD DESCRIPTION</i>	<i>Key</i>	<i>ST</i>	<i>FM</i>	<i>Table Field</i>	<i>Action</i>	<i>Table Field</i>	<i>Action</i>
8.	Ship From Business Partner Address second part of the name		C	an..30	tccom130.namb	ORD3	tccom130.namb	
9.	Ship From Business Partner Address third part of the name		C	an..30	tccom130.namc	ORD3	tccom130.namc	
10.	Ship From Business Partner Address 2		C	an..30	tccom130.namd	ORD3	tccom130.namd	
11.	Ship From Business Partner Address City		C	an..30	tccom130.name	ORD3	tccom130.name	
12.	ILN Code, Ship From Business Partner Address		C	an..30	tccom130.namf	ORD3	tccom130.namf	
13.	Ship From Business Partner Address Zip Code		C	an..10	tccom130.pstc	ORD3	tccom130.pstc	
14.	Ship From Business Partner Address Tax Id		C	an..20	tccom130.fovn	ORD3	tccom130.fovn	
15.								
16.	TAX Code Id Qualifier		M	an3	“VAT”	ORD3		
17.	Ship From Business Partner Address State / Province		C	an..2	tccom130.cste	ORD3	tccom130.cste	

<i>ORDER INHOUSE FORMAT</i>					<i>Mapping from Application Table Fields</i>		<i>Mapping to Application Fields</i>	
<i>Pos</i>	<i>FIELD DESCRIPTION</i>	<i>Key</i>	<i>ST</i>	<i>FM</i>	<i>Table Field</i>	<i>Action</i>	<i>Table Field</i>	<i>Action</i>
18.	Ship From Business Partner Telephone Number		C	an..15	tccom130.telp	ORD3	tccom130.telp	
19.	Ship From Business Partner Telex Number		C	an..15	tccom130.telx	ORD3	tccom130.telx	
20.	Ship From Business Partner Fax Number		C	an..15	tccom130.tefx	ORD3	tccom130.tefx	
21.	Ship From Business Partner GEO Code		C	an..10	tccom130.geoc	ORD3	tccom130.geoc	
22.	Ship From Business Partner House Number		C	an..10	tccom130.hono	ORD3	tccom130.hono	
23.	Ship From Business Partner P. O. Box Number		C	an..10	tccom130.pobn	ORD3	tccom130.pobn	
24.	Data record end sign		M	an7	SA4_END	ORD3	SA4_END	

Evaluation Expression.

ORD3: (strip(tdpur400.sfad) <> "" and tdpur400.sfad <> tccom121.cadr)

Second Appearance: Warehouse Address (Address Qualifier: CWAR)

<i>ORDER INHOUSE FORMAT</i>					<i>Mapping from Application Table Fields</i>		<i>Mapping to Application Fields</i>	
<i>Pos</i>	<i>FIELD DESCRIPTION</i>	<i>Key</i>	<i>ST</i>	<i>FM</i>	<i>Table Field</i>	<i>Action</i>	<i>Table Field</i>	<i>Action</i>
1.	Kind of data record	O/I	M	an3	SA4		SA4	
2.	Message reference	O/I	M	an..14	ecedi701.bano		ecedi702.bano	
3.	Identification of the Sender	O/I	M	an..17	ecedi020.neta	Conversion	tdsls400.ofbp	Conversion
4.	Order Number	O/I	M	n..6 an..30	tdpur400.orno		tdsls400.com	
5.	Address Qualifier Warehouse Address		M	an4	"CWAR"			
6.	Warehouse Address Country		C	an..6	tccom130.ccty	ORD6	tccom130.ccty	Code and Conversion
7.	Warehouse Address first part of the name		C	an..35	tccom130.nama	ORD6	tccom130.nama	
8.	Warehouse Address second part of the name		C	an..30	tccom130.namb	ORD6	tccom130.namb	
9.	Warehouse Address third part of the name		C	an..30	tccom130.name	ORD6	tccom130.name	
10.	Warehouse Address 2		C	an..30	tccom130.namd	ORD6	tccom130.namd	
11.	Warehouse Address City		C	an..30	tccom130.name	ORD6	tccom130.name	

<i>ORDER INHOUSE FORMAT</i>					<i>Mapping from Application Table Fields</i>		<i>Mapping to Application Fields</i>	
<i>Pos</i>	<i>FIELD DESCRIPTION</i>	<i>Key</i>	<i>ST</i>	<i>FM</i>	<i>Table Field</i>	<i>Action</i>	<i>Table Field</i>	<i>Action</i>
12.	ILN Code, Warehouse Address		C	an..30	tccom130.namf	ORD6	tccom130.namf	
13.	Warehouse Address Zip Code		C	an..10	tccom130.pstc	ORD6	tccom130.pstc	
14.	Warehouse Address Tax Id		C	an..20	tccom130.fovn	ORD6	tccom130.fovn	
15.	empty Position		C	an..35	for later use	ORD6	for later use	
16.	TAX Code Id Qualifier		M	an3	“VAT”	ORD6	“VAT”	
17.	Warehouse Address State / Province Code		C	an..2	tccom130.cste	ORD6	tccom130.cste	
18.	Warehouse Address Telephone Number		C	an..15	tccom130.telp	ORD6	tccom130.telp	
19.	Warehouse Address Telex Number		C	an..15	tccom130.telx	ORD6	tccom130.telx	
20.	Fax Number		C	an..15	tccom130.tefx	ORD6	tccom130.tefx	
21.	Warehouse Address GEO Code		C	an..10	tccom130.geoc	ORD6	tccom130.geoc	
22.	Warehouse Address House Number		C	an..10	tccom130.hono	ORD6	tccom130.hono	
23.	Warehouse Address P. O. Box Number		C	an..10	tccom130.pobn	ORD6	tccom130.pobn	

Data record **description by kind of data record**

<i>ORDER INHOUSE FORMAT</i>					<i>Mapping from Application Table Fields</i>		<i>Mapping to Application Fields</i>	
<i>Pos</i>	<i>FIELD DESCRIPTION</i>	<i>Key</i>	<i>ST</i>	<i>FM</i>	<i>Table Field</i>	<i>Action</i>	<i>Table Field</i>	<i>Action</i>
24.	Data record end sign		M	an7	SA4_END	ORD6	SA4_END	

Evaluation Expression.

ORD6: strip(tpur400.cadr) <> "" and tpur400.cadr <> tcmcs003.cadr)

Detailed description: Specific Order Addresses
Kind of data record: SA4 Specific Order Addresses

**First Appearance: Ship from Business partner Address
 (Address Qualifier: SFBP)**

Position	1	Field format	an3	Field status	M
Field name		Kind of data record		(Key field out/in)	

Description: This field identifies the kind of data record in the message block. It contains the constant value 'SA4'.

Processing outgoing

EDI Sub-System:

BAAN: This field will be filled with the constant value 'SA4'.

Processing incoming

EDI Sub-System: This field will be filled with the constant value 'SA4'.

BAAN:

Position	2	Field format	an..14	Field status	M
Field name		Message reference		(Key field out/in)	

Description: This field identifies all connected data records of one order. The numbering of the message reference, which has to be clear by Order, helps to control the chronological order of the Orders and the complete transmission.

Processing outgoing

EDI Sub-System:

BAAN: Refer to data record SA2.

Processing incoming

EDI Sub-System: Refer to data record SA2

BAAN:

Position	3	Field format	an..17	Field status	M
Field name	Identification of the sender		(Key field out)		

Description: This field contains the identification code of the sender.

Processing outgoing

EDI Sub-System:

BAAN: Refer to data record SA2

Processing incoming

EDI Sub-System: Refer to data record SA2

BAAN: Refer to data record SA2

Position	4	Field format	an..9/an..30	Field status	M
Field name	Order Number		(Key field in/out)		

Description: This field contains the order number.

Processing outgoing

EDI Sub-System: None.

BAAN: Refer to data record SA2.

Processing incoming

EDI Sub-System:

BAAN: Refer to data record SA2

Position	5	Field format	an4	Field status	M
Field name	Address Qualifier Address Ship From B.P.				

Description: This field contains the Qualifier which identifies the next data set as an ship from or an ship to address.

SFBP The following data is the Ship From Address

CWAR The following data is the Ship to (delivery) address

This qualifier must be entered in BAAN table TBecedi224 regarding to the used organization.

Processing outgoing

EDI Sub-System:

BAAN: The value "SFBP" or is filled in from BAAN table field ecedi224.code.

Processing incoming

EDI Sub-System:

The value "SFBP" is filled in this position.

BAAN: Mapping to BAAN table field TFtdsls042.ckor and Conversion with TBecedi224.

Position	6	Field format	an..6	Field status	C
Field name	Ship From B. P. Address Country				

Description: This field contains the Country of the Address. The following country codes are defined in BAAN table TBecedi226 according to ODDC 6

AT: Austria
BE: Belgium
CH: Switzerland
DE: Federal Republik of Germany
DK: Denmark
ES: Spain
FI: Finland
FR: France
GB: United Kingdom
GR: Greece
IE: Ireland
IT: Italy
LU: Luxembourg
NL: Netherlands
NO: Norway
PT: Portugal
SE: Sweden
TR: Turkey
YU: Yugoslavia

Processing outgoing

EDI Sub-System:

BAAN: The country code of the delivery address from BAAN table field tccom130.ccty is mapped to this position and converts with BAAN table TBecedi440.

Processing incoming

EDI Sub-System: Transmission of the value from the message file.

BAAN: Mapping to the BAAN table field TFtccom130.ccty and conversion with BAAN table TBecedi302.

Position	7	Field format	an..35	Field status	C
Field name	Ship From B. P. Address First part of Name				

Description: This field contains the first part of the name.

Processing outgoing

EDI Sub-System:

BAAN: The First part of the Name from BAAN table field TFtccom130.nama is mapped to this position.

Processing incoming

EDI Sub-System: Transmission of the value from the message file.

BAAN: Mapping to the BAAN table field TFtccom130.nama

Position	8	Field format	an..30	Field status	C
Field name	Ship From B. P. Address Second part of Name				

Description: This field contains the second part of the name.

Processing outgoing

EDI Sub-System:

BAAN: The Second part of the Name from BAAN table field TFtccom130.namb is mapped to this position.

Processing incoming

EDI Sub-System: Transmission of the value from the message file.

BAAN: Mapping to the BAAN table field TFtccom130.namb

Position	9	Field format	an..30	Field status	C
Field name	Ship From B. P. Address 3rd part of the name				

Description: This field contains the first part of the Delivery Address.

Processing outgoing

EDI Sub-System:

BAAN: The first part of the Address from BAAN table field TFtccom130.namc is mapped to this position.

Processing incoming

EDI Sub-System: Transmission of the value from the message file.

BAAN: Mapping to the BAAN table field TFtccom130.namc

Position	10	Field format	an..30	Field status	C
Field name	Ship From B. P. Address 2				

Description: This field contains the second part of the delivery address.

Processing outgoing

EDI Sub-System:

BAAN: The second part of the Address from BAAN table field TFtccom130.namd is mapped to this position.

Processing incoming

EDI Sub-System: Transmission of the value from the message file.

BAAN: Mapping to the BAAN table field TFtccom130.namd

Position	11	Field format	an..30	Field status	C
Field name	Ship From B. P. Address City				

Description: This field contains the name of the City.

Processing outgoing

EDI Sub-System:

BAAN: The name of the City from BAAN table field TFtccom130. name is mapped to this position.

Processing incoming

EDI Sub-System: Transmission of the value from the message file.

BAAN: Mapping to the BAAN table field TFtccom130.name

Position	12	Field format	an..30	Field status	C
Field name	ILN Code / Ship From B. P. further information province or country				

Description: This field contains further information to the City (province/country)

Processing outgoing

EDI Sub-System:

BAAN: The ILN-Code from BAAN table field TFtccom130.namf is mapped to this position.

Processing incoming

EDI Sub-System: Transmission of the value from the message file.

BAAN: The ILN-Code is mapped to BAAN table field TFtccom130.namf.

Position	13	Field format	an..10	Field status	C
Field name	Ship From B. P. Address Zip Code				

Description: This field contains the postal or zip Code referring to the Address.

Processing outgoing

EDI Sub-System:

BAAN: The Zip Code from BAAN table field Tftccom130.pstc is mapped to this position.

Processing incoming

EDI Sub-System: Transmission of the value from the message file.

BAAN: Mapping to the BAAN table field Tftccom130.pstc

Position	14	Field format	an..20	Field status	C
Field name	Ship From B. P. Address Tax ID				

Description: This field contains the Tax ID.

Processing outgoing

EDI Sub-System:

BAAN: The tax ID of BAAN table field Tftccom130.fovn is mapped to this position.

Processing incoming

EDI Sub-System: Transmission of the value from the message file.

BAAN: Mapped to BAAN table field tcom130.fovn.

Position	15	Field format	an..35	Field status	C
Field name	empty Position				

Description: empty position for later use.

Processing outgoing

EDI Sub-System:

BAAN: None.

Processing incoming

EDI Sub-System:

BAAN: None.

Position	16	Field format	an3	Field status	M
Field name	Tax ID Qualifier				

Description: This field contains the Tax Code ID Qualifier "VAT".

Processing outgoing

EDI Sub-System:

BAAN: This field is filled with the constant value "VAT".

Processing incoming

EDI Sub-System:

BAAN: None

Position	17	Field format	an..2	Field status	C
Field name	Ship From B. P. Adress State/Province Code				

Description: This field contains the code for the State / Province. The tax provider identifies the tax jurisdictions by means of GEO codes. The GEO codes are assigned to the addresses, based on the following address data:

City
State/province and
ZIP/postal code

Processing outgoing

EDI Sub-System:

BAAN: The State /Province Code from BAAN table field TFtccom130.cste is mapped to this position.

Processing incoming

EDI Sub-System: Transmission of the value from the message file.

BAAN: Mapped to BAAN table field tccom130.cste.

Position	18	Field format	an..15	Field status	C
Field name	Ship From B. P. Telephon Number				

Description: This field contains the Telephone Number.

Processing outgoing

EDI Sub-System:

BAAN: The telephone number of BAAN table field TFtccom130.telp is mapped to this position.

Processing incoming

EDI Sub-System: Transmission of the value from the message file.

BAAN: Mapped to BAAN table field tccom130.telp.

Position	19	Field format	an..15	Field status	C
Field name	Ship From B. P. Telex Number				

Description: This field contains the Telex Number.

Processing outgoing

EDI Sub-System:

BAAN: The telex number of BAAN table field
TFtccom130.telx is mapped to this position.

Processing incoming

EDI Sub-System: Transmission of the value from the message file.

BAAN: Mapped to BAAN table field tccom130.telx.

Position	20	Field format	an..15	Field status	C
Field name	Ship From B. P. Fax Number				

Description: This field contains the Faxnumber.

Processing outgoing

EDI Sub-System:

BAAN: The Faxnumber of BAAN table field
TFtccom130.tefx is mapped to this position.

Processing incoming

EDI Sub-System: Transmission of the value from the message file.

BAAN: Mapped to BAAN table field tccom130.tefx.

Position	21	Field format	an..10	Field status	C
Field name	Ship From B. P. GEO Code				

Description: This field contains the GEO-Code.

Processing outgoing

EDI Sub-System:

BAAN: The GEO-Code of BAAN table field
TFtccom130.deoc is mapped to this position.

Processing incoming

EDI Sub-System: Transmission of the value from the message file.

BAAN: Mapped to BAAN table field tccom130.geoc.

Position	22	Field format	an..10	Field status	C
Field name	Ship From B. P. Housenumber				

Description: This field contains the housenumber of the address.

Processing outgoing

EDI Sub-System:

BAAN: The housenumber of BAAN table field
TFtccom130.hono is mapped to this position.

Processing incoming

EDI Sub-System: Transmission of the value from the message file.

BAAN: Mapped to BAAN table field tccom130.hono.

Position	23	Field format	an..10	Field status	C
Field name	Ship From B. P. P.O.Box Number				

Description: This field contains the P.O. Box Number.

Processing outgoing

EDI Sub-System:

BAAN: The P.O. Box Number of BAAN table field Tftccom130.pobn is mapped to this position.

Processing incoming

EDI Sub-System: Transmission of the value from the message file.

BAAN: Mapped to BAAN table field tccom130.pobn.

Position	24	Field format	an7	Field status	M
Field name	Data record end sign				

Description: This field indicates the end of the data record. It contains the constant value 'SA4_END'.

Processing outgoing

EDI Sub-System:

BAAN: This field will be filled with the constant value 'SA4_END'.

Processing incoming

EDI Sub-System: This field will be filled with the constant value 'SA4_END'.

BAAN: None

**Second Appearance: Warehouse Address
(Address Qualifier: CWAR)**

Position	1	Field format	an3	Field status	M
Field name		Kind of data record		(Key field out/in)	

Description: This field identifies the kind of data record in the message block. It contains the constant value 'SA4'.

Processing outgoing

EDI Sub-System:

BAAN: This field will be filled with the constant value 'SA4'.

Processing incoming

EDI Sub-System: This field will be filled with the constant value 'SA4'.

BAAN:

Position	2	Field format	an..14	Field status	M
Field name		Message reference		(Key field out/in)	

Description: This field identifies all connected data records of one order. The numbering of the message reference, which has to be clear by Order, helps to control the chronological order of the Orders and the complete transmission.

Processing outgoing

EDI Sub-System:

BAAN: Refer to data record SA2.

Processing incoming

EDI Sub-System: Refer to data record SA2

BAAN:

Position	3	Field format	an..17	Field status	M
Field name	Identification of the sender		(Key field out)		

Description: This field contains the identification code of the sender.

Processing outgoing

EDI Sub-System:

BAAN: Refer to data record SA2

Processing incoming

EDI Sub-System: Refer to data record SA2

BAAN: Refer to data record SA2

Position	4	Field format	an..9/an..30	Field status	M
Field name	Order Number		(Key field in/out)		

Description: This field contains the order number.

Processing outgoing

EDI Sub-System: None.

BAAN: Refer to data record SA2.

Processing incoming

EDI Sub-System:

BAAN: Refer to data record SA2

Position	5	Field format	an4	Field status	M
Field name	Address Qualifier Warehouse Specific Address				

Description: This field contains the Qualifier which identifies the next data set as an ship from or an ship to address.

SFBP The following data is the Ship From Address

CWAR The following data is the Ship to (delivery) address

This qualifier must be entered in BAAN table TBecedi224 regarding to the used organization.

Processing outgoing

EDI Sub-System:

BAAN: The value "CWAR" or is filled in from BAAN table field ecedi224.code.

Processing incoming

EDI Sub-System:

The value "CWAR" is filled in this position.

BAAN:

Mapping to BAAN table field TFtdsls042.ckor and Conversion with Tbecedi224..

Position	6	Field format	an..6	Field status	C
Field name	Warehouse Address Country				

Description: This field contains the Country of the Address.
The following country codes are defined in
BAAN table TBecedi226 according to ODDC 6

AT: Austria
 BE: Belgium
 CH: Switzerland
 DE: Federal Republik of Germany
 DK: Denmark
 ES: Spain
 FI: Finland
 FR: France
 GB: United Kingdom
 GR: Greece
 IE: Ireland
 IT: Italy
 LU: Luxembourg
 NL: Netherlands
 NO: Norway
 PT: Portugal
 SE: Sweden
 TR: Turkey
 YU: Yugoslavia

Processing outgoing

EDI Sub-System:

BAAN: The country code of the address from BAAN
table field tccom130.ccty is mapped to this
position and converts with BAAN table
TBecedi440.

Processing incoming

EDI Sub-System:

Transmission of the value from the message file.

BAAN:

Mapping to the BAAN table field
Tftccom130.ccty and conversion with BAAN
table TBecedi302.

Position	7	Field format	an..35	Field status	C
Field name	Address First part of Name				

Description: This field contains the first part of the name.

Processing outgoing

EDI Sub-System:

BAAN: The First part of the Name from BAAN table field TFtccom130.nama is mapped to this position.

Processing incoming

EDI Sub-System: Transmission of the value from the message file.

BAAN: Mapping to the BAAN table field TFtccom130.nama

Position	8	Field format	an..30	Field status	C
Field name	Warehouse Address Second part of Name				

Description: This field contains the second part of the name.

Processing outgoing

EDI Sub-System:

BAAN: The Second part of the Name from BAAN table field TFtccom130.namb is mapped to this position.

Processing incoming

EDI Sub-System: Transmission of the value from the message file.

BAAN: Mapping to the BAAN table field TFtccom130.namb

Position	9	Field format	an..30	Field status	C
Field name	Warehouse Address 3rd part of the name				

Description: This field contains the first part of the Address.

Processing outgoing

EDI Sub-System:

BAAN: The first part of the Address from BAAN table field TFtccom130.namc is mapped to this position.

Processing incoming

EDI Sub-System: Transmission of the value from the message file.

BAAN: Mapping to the BAAN table field TFtccom130.namc

Position	10	Field format	an..30	Field status	C
Field name	Warehouse Address 2				

Description: This field contains the second part of the address.

Processing outgoing

EDI Sub-System:

BAAN: The second part of the Address from BAAN table field TFtccom130.namd is mapped to this position.

Processing incoming

EDI Sub-System: Transmission of the value from the message file.

BAAN: Mapping to the BAAN table field TFtccom130.namd

Position	11	Field format	an..30	Field status	C
Field name	Warehouse Address City				

Description: This field contains the name of the City.

Processing outgoing

EDI Sub-System:

BAAN: The name of the City from BAAN table field TFtccom130. name is mapped to this position.

Processing incoming

EDI Sub-System: Transmission of the value from the message file.

BAAN: Mapping to the BAAN table field TFtccom130.name

Position	12	Field format	an..30	Field status	C
Field name	ILN Warehouse Code / further information province or country				

Description: This field contains further information to the City (province/country)

Processing outgoing

EDI Sub-System:

BAAN: The ILN-Code from BAAN table field TFtccom130.namf is mapped to this position.

Processing incoming

EDI Sub-System: Transmission of the value from the message file.

BAAN: The ILN-Code is mapped to BAAN table field TFtccom130.namf.

Position	13	Field format	an..10	Field status	C
Field name	Warehouse Address Zip Code				

Description: This field contains the postal or zip Code referring to the Address.

Processing outgoing

EDI Sub-System:

BAAN: The Zip Code from BAAN table field TFtccom130.pstc is mapped to this position.

Processing incoming

EDI Sub-System: Transmission of the value from the message file.

BAAN: Mapping to the BAAN table field TFtccom130.pstc

Position	14	Field format	an..20	Field status	C
Field name	Warehouse Address Tax ID				

Description: This field contains the Tax ID.

Processing outgoing

EDI Sub-System:

BAAN: The tax ID of BAAN table field TFtccom130.fovn is mapped to this position.

Processing incoming

EDI Sub-System: Transmission of the value from the message file.

BAAN: Mapped to BAAN table field tccom130.fovn.

Position	15	Field format	an..35	Field status	C
Field name	empty Position				

Description: empty position for later use.

Processing outgoing

EDI Sub-System:

BAAN: None.

Processing incoming

EDI Sub-System:

BAAN: None.

Position	16	Field format	an3	Field status	M
Field name	Tax ID Qualifier				

Description: This field contains the Tax Code ID Qualifier "VAT".

Processing outgoing

EDI Sub-System:

BAAN: This field is filled with the constant value "VAT".

Processing incoming

EDI Sub-System:

BAAN: None

Position	17	Field format	an..2	Field status	C
Field name	Warehouse Address State/Province Code				

Description: This field contains the code for the State / Province. The tax provider identifies the tax jurisdictions by means of GEO codes. The GEO codes are assigned to the addresses, based on the following address data:

City

State/province and

ZIP/postal code

Processing outgoing

EDI Sub-System:

BAAN: The State /Province Code from BAAN table field TFtccom130.cste is mapped to this position.

Processing incoming

EDI Sub-System: Transmission of the value from the message file.

BAAN: Mapped to BAAN table field tccom130.cste.

Position	18	Field format	an..15	Field status	C
Field name	Warehouse Address Telephone Number				

Description: This field contains the Telephone Number.

Processing outgoing

EDI Sub-System:

BAAN: The telephone number of BAAN table field TFtccom130.telp is mapped to this position.

Processing incoming

EDI Sub-System: Transmission of the value from the message file.

BAAN: Mapped to BAAN table field tccom130.telp.

Position	19	Field format	an..15	Field status	C
Field name	Warehouse Address Telex Number				

Description: This field contains the Telex Number.

Processing outgoing

EDI Sub-System:

BAAN: The telex number of BAAN table field TFtccom130.telx is mapped to this position.

Processing incoming

EDI Sub-System: Transmission of the value from the message file.

BAAN: Mapped to BAAN table field tccom130.telx.

Position	20	Field format	an..15	Field status	C
Field name	Warehouse Address Fax Number				

Description: This field contains the Faxnumber.

Processing outgoing

EDI Sub-System:

BAAN: The Faxnumber of BAAN table field TFtccom130.tefx is mapped to this position.

Processing incoming

EDI Sub-System: Transmission of the value from the message file.

BAAN: Mapped to BAAN table field tccom130.tefx.

Position	21	Field format	an..10	Field status	C
Field name	Warehouse Address GEO Code				

Description: This field contains the GEO-Code.

Processing outgoing

EDI Sub-System:

BAAN: The GEO-Code of BAAN table field
TFtccom130.deoc is mapped to this position.

Processing incoming

EDI Sub-System: Transmission of the value from the message file.

BAAN: Mapped to BAAN table field tccom130.geoc.

Position	22	Field format	an..10	Field status	C
Field name	Warehouse Address Housenumber				

Description: This field contains the housenumber of the
address.

Processing outgoing

EDI Sub-System:

BAAN: The housenumber of BAAN table field
TFtccom130.hono is mapped to this position.

Processing incoming

EDI Sub-System: Transmission of the value from the message file.

BAAN: Mapped to BAAN table field tccom130.hono.

Position	23	Field format	an..10	Field status	C
Field name	Warehouse Address P.O.Box Number				

Description: This field contains the P.O. Box Number.

Processing outgoing

EDI Sub-System:

BAAN: The P.O. Box Number of BAAN table field TFtccom130.pobn is mapped to this position.

Processing incoming

EDI Sub-System: Transmission of the value from the message file.

BAAN: Mapped to BAAN table field tccom130.pobn.

Position	24	Field format	an7	Field status	M
Field name	Data record end sign				

Description: This field indicates the end of the data record. It contains the constant value 'SA4_END'.

Processing outgoing

EDI Sub-System:

BAAN: This field will be filled with the constant value 'SA4_END'.

Processing incoming

EDI Sub-System: This field will be filled with the constant value 'SA4_END'.

BAAN: None

SA5 Order Lines

Status : Mandatory
 Frequency : Multiple times per order number
 Description: This data records contain the information about the ordered items. It is related to SA2.

<i>ORDER INHOUSE FORMAT</i>					<i>Mapping from Application Table Fields</i>		<i>Mapping to Application Fields</i>	
<i>Pos</i>	<i>FIELD DESCRIPTIO N</i>	<i>Key</i>	<i>ST</i>	<i>FM</i>	<i>Table Field</i>	<i>Action</i>	<i>Table Field</i>	<i>Action</i>
1.	Kind of data record	O/I	M	an3	SA5		SA5	
2.	Message reference	O/I	M	an..14	ecedi701.bano		ecedi702.bano	
3.	Identification of the sender	O/I	M	an..17	ecedi020.neta	Conversion	tdsls400.ofbp	Conversion
4.	Order Number	O/I	M	n..9 an..30	tdpur400.orno		tdsls401.corn	
5.	Order Position Number		M	n..5 an..16	tdpur401.pono		tdsls401.corp	
6.	Buyer's Item Code or EAN Item Code		C	an..47	tdpur401.item	(for EAN Conversion)	tdsls401.item	Conversion
7.	Supplier's Item Code		C	an..47	tdpur401.item	Conversion		
8.	Qualifier Item Code		M	an2	SA		SA or None	depends on Conversion
9.	Description of the Item		C	an..30	tcibd001.dsca			
10.	Item's price		C	n..19	tdpur401.pric		tdsls401.pric	

Data record **description by kind of data record**

<i>ORDER INHOUSE FORMAT</i>					<i>Mapping from Application Table Fields</i>		<i>Mapping to Application Fields</i>	
<i>Pos</i>	<i>FIELD DESCRIPTION</i>	<i>Key</i>	<i>ST</i>	<i>FM</i>	<i>Table Field</i>	<i>Action</i>	<i>Table Field</i>	<i>Action</i>
11.	Purchase/Sales Unit		C	an..3	tdpur401.cuqp	Code and Conversion	tdsls401.cuqs	Code and Conversion
12.	Ordered Quantity		C	n..15	tdpur401.oqua		tdsls401.oqua	
13.	Planned Delivery Date / Time		C	n..14	tdpur401.ddta		tdsls401.ddta	
14.	Purchase / Sales Price Unit		C	an..3	tdpur401.cupp	Code and Conversion	tdsls401.cups	Code and Conversion
15.	Tax Code		C	an..10	tdpur401.cvat	Code and Conversion		
16.	Country Code linked to the Tax Code		C	an..6	tdpur401.ccty	Code and Conversion		
17.	Length of the Item		C	n..8	tdpur401.leng		tdsls401.leng	
18.	Width of the Item		C	n..8	tdpur401.widt		tdsls401.widt	
19.	Height or Thickness of the Item		C	n..8	tdpur401.thic		tdsls401.thic	
20.	Back Order Quantity		C	n..15	tdpur401.bqua			
21.	Discount Code 1		C	an..20	tdpur401.cdis(1)	Code- and Conversion	tdsls401.cdis(1)	Code- and Conversion
22.	Order Line Discount Amount 1		C	n..15	tdpur401.ldam(1)		tdsls401.ldam(1)	
23.	Discount Code 2		C	an..20	tdpur401.cdis(2)	Code- and Conversion	tdsls401.cdis(2)	Code- and Conversion

Definition of BEMIS V ORD001A Import and Export File for the Message Trading Orders
2-84

<i>ORDER INHOUSE FORMAT</i>					<i>Mapping from Application Table Fields</i>		<i>Mapping to Application Fields</i>	
<i>Pos</i>	<i>FIELD DESCRIPTION</i>	<i>Key</i>	<i>ST</i>	<i>FM</i>	<i>Table Field</i>	<i>Action</i>	<i>Table Field</i>	<i>Action</i>
24.	Order Line Discount Amount 2		C	n..15	tdpur401.ldam(2)		tdsls401.ldam(2)	
25.	Discount Code 3		C	an..20	tdpur401.cdis(3)	Code- and Conversion	tdsls401.cdis(3)	Code- and Conversion
26.	Order Line Discount Amount 3		C	n..15	tdpur401.ldam(3)		tdsls401.ldam(3)	
27.	Order Line Text 1		C	an..70	tdpur401.txta(1)		tdsls401.txta(1)	
28.	Order Line Text 2		C	an..70	tdpur401.txta(2)		tdsls401.txta(2)	
29.	Qualifier Tax Code Id		M	an3	''VAT''			
30.	Order Date / Time		C	n..14	tdpur401.odat		tdsls401.odat	
31.	Current Planned Receipt Date / Time		C	n..14			tdsls401.prdt	
32.	empty position		C	an..35	for later use		for later use	
33.	Order Line Discount Percentage 1		C	n..6	tdpur401.disc(1)	NNN.NN	tdsls401.disc(1)	
34.	Order Line Discount Percentage 2		C	n..6	tdpur401.disc(2)	NNN.NN	tdsls401.disc(2)	
35.	Order Line Discount Percentage 3		C	n..6	tdpur401.disc(3)	NNN.NN	tdsls401.disc(3)	

<i>ORDER INHOUSE FORMAT</i>					<i>Mapping from Application Table Fields</i>		<i>Mapping to Application Fields</i>	
<i>Pos</i>	<i>FIELD DESCRIPTIO N</i>	<i>Key</i>	<i>ST</i>	<i>FM</i>	<i>Table Field</i>	<i>Action</i>	<i>Table Field</i>	<i>Action</i>
36.	Order Line Discount Percentage 4		C	n..6	tdpur041.disc(4)	NNN.NN	tdsls401.disc(3)	
37.	Order Line Discount Percentage 5		C	n..6	tdpur041.disc(5)	NNN.NN	tdsls401.disc(5)	
38.	Discount Code 4		C	an..20	tdpur401.cdis(4)	Code- and Conversion	tdsls401.cdis(4)	Code- and Conversion
39.	Discount Code 5		C	an..20	tdpur401.cdis(5)	Code- and Conversion	tdsls401.cdis(5)	Code- and Conversion
40.	Order Line Discount Amount 4		C	n..19	tdpur401.ldam(4)		tdsls401.ldam(3)	
41.	Order Line Discount Amount 5		C	n..19	tdpur401.ldam(5)		tdsls401.ldam(3)	
42.	Discount Method 1		C	an..20	tdpur401.dmth(1)	Code- and Conversion	tdsls401.dmth(1)	
43.	Discount Method 2		C	an..20	tdpur401.dmth(2)	Code- and Conversion	tdsls401.dmth(2)	
44.	Discount Method 3		C	an..20	tdpur401.dmth(3)	Code- and Conversion	tdsls401.dmth(3)	
45.	Discount Method 4		C	an..20	tdpur401.dmth(4)	Code- and Conversion	tdsls401.dmth(4)	
46.	Discount Method 5		C	an..20	tdpur401.dmth(5)	Code- and Conversion	tdsls401.dmth(5)	
47.	Manufacturer		C	an..6	tdpur401.cmnf		tdsls401.cmnf	

<i>ORDER INHOUSE FORMAT</i>					<i>Mapping from Application Table Fields</i>		<i>Mapping to Application Fields</i>	
<i>Pos</i>	<i>FIELD DESCRIPTION</i>	<i>Key</i>	<i>ST</i>	<i>FM</i>	<i>Table Field</i>	<i>Action</i>	<i>Table Field</i>	<i>Action</i>
48.	Product Class		C	an..6	tdpur401.cpcl		tdsls401.cpcl	
49.	Confirmed Delivery Date / Time		C	n..14	tdpur401.ddtb tdpur401.ddtc	Evaluation Expression ORD7		
50.	Forwarding Agent		C	an..20	tdpur401.cfrw	Code and Conversion	tdsls401.cfrw	Code and Conversion
51.	Ship from Business Partner		C	an..20	tdpur401.sfbp	Code and Conversion	tdsls401.cwar	Code and Conversion
52.	Qualifier Address / Partner Code		C	an4	ecedi224.code		“SFBP”	
53.	Warehouse Code		C	an..20	tdpur401.cwar	Code and Conversion	tdsls401.stbp	Code and Conversion
54.	Qualifier Address / Warehouse Code		C	an4	ecedi224.code		“CWAR”	
55.	Ordered Amount		C	n..13	tdpur401.oamt			
56.	Qualifier		C	an2	“ZZ”			
57.	Qualifier Sold To Business Partner			an4			“STBP”	
58.	Data record end sign		M	an7	SA5_END		SA5_END	

Evaluation Expression:

ORD7: tdpur401.ddtc <> 0

Detailed description:	Order Lines
Kind of data record:	SA5 Order Lines

Position	1	Field format	an3	Field status	M
Field name		Kind of data record		(Key field out/in)	

Description: This field identifies the kind of data record in the message block. It contains the constant value 'SA5'.

Processing outgoing

EDI Sub-System:

BAAN: This field will be filled with the constant value 'SA5'.

Processing incoming

EDI Sub-System: This field will be filled with the constant value 'SA5'.

BAAN:

Position	2	Field format	an..14	Field status	M
Field name		Message reference		(Key field out/in)	

Description: This field identifies all connected data records of one order. The numbering of the message reference, which has to be clear by Order, helps to control the chronological order of the Orders and the complete transmission.

Processing outgoing

EDI Sub-System:

BAAN: Refer to data record SA2.

Processing incoming

EDI Sub-System: Refer to data record SA2

BAAN:

Position	3	Field format	an..17	Field status	M
Field name	Identification of the Sender		(Key field out)		

Description: This field contains the identification of the sender.

Processing outgoing

EDI Sub-System:

BAAN: Refer to data record SA2

Processing incoming

EDI Sub-System: Refer to data record SA2

BAAN: Refer to data record SA2

Position	4	Field format	n..9 /an..30	Field status	M
Field name	Order Number		(Key field in/out)		

Description: This field contains the order number.

Processing outgoing

EDI Sub-System: None.

BAAN: The purchase order number is mapped from BAAN table field TFtdpur400.orno to this position.

Processing incoming

EDI Sub-System: Transmission of the value from the message file.

BAAN: Mapping to BAAN table field TFtdsls400.com

Position	5	Field format	n..5/an..16	Field status	M
Field name	Order Position Number				

Description: This field contains the Order Position Number.

Processing outgoing

EDI Sub-System:

BAAN: The order line number of the lines of the purchase order from BAAN table field TFtdpur401.pono is mapped to this position.

Processing incoming

EDI Sub-System: Transmission of the value from the message file.

BAAN: Mapping to BAAN table field TFtdsls401.corp

Position	6	Field format	an..16	Field status	C
Field name	Buyer's Item Code / EAN Item Code				

Description: This field contains the Buyer's Item Code.

Processing outgoing

EDI Sub-System:

BAAN: The item code from BAAN table field TFtdpur401.item is mapped to this position. If the buyer wants to send out the EAN Item Code a conversion is needed. This means that the buyers item code has to convert using the code and conversion table TBecedi444. Furthermore please notice, that the conversion setup has to be adapted to the demand under the use of the qualifier "SA" or "EAN".

Processing incoming

EDI Sub-System: Transmission of the value from the message file.

BAAN: Mapping to the BAAN table field TFtdsls401.item after conversion with qualifier "SA" or "EAN". If no conversion should take place, the Qualifier on position 8 must be empty.

Position	7	Field format	an..16	Field status	C
Field name	Supplier's item code				

Description: This field contains the Supplier item Code.

Processing outgoing

EDI Sub-System:

BAAN: The supplier item code from BAAN table field TFtdpur401.item is mapped to this position after conversion with qualifier "SA".

Processing incoming

EDI Sub-System: Transmission of the value from the message file.

BAAN: None.

Position	8	Field format	an2	Field status	C
Field name	Qualifier Item Code				

Description: This field contains the qualifier for the item code. The constant value 'SA' indicates, that the supplier item codes are used. 'EAN' means that the EAN Code is used.

Processing outgoing

EDI Sub-System:

BAAN: This field will be filled with the constant value 'SA' or 'EAN'.

Processing incoming

EDI Sub-System: This field will be filled with the constant value 'SA' or 'EAN', if the supplier item code or the EAN Code on position 6 is used.

BAAN: Used as qualifier for the conversion of the item code.

Position	9	Field format	an..30	Field status	C
Field name	Description of the item				

Description: This field contains the description of the item.

Processing outgoing

EDI Sub-System:

BAAN: The description of the item from BAAN table field TFtcibd001.dsca is mapped to this position.

Processing incoming

EDI Sub-System: Transmission of the value from the message file.

BAAN: None.

Position	10	Field format	n..15	Field status	C
Field name	Price				

Description: This field contains the price of the item.
Format: NNNNNNNNNNNNNNN.NNNN

Processing outgoing

EDI Sub-System:

BAAN: The price from BAAN table field TFtdpur401.pric is mapped to this position.

Processing incoming

EDI Sub-System: Transmission of the value from the message file.

BAAN: Mapping to the BAAN table field TFtdsls401.pric

Position	11	Field format	an..3	Field status	C
Field name	Purchase/Sales Unit				

Description: This field contains the purchase/sales unit of the item. The coding was carried out on the basis of ODETTE-Standard ODDC 25:

Millimeter	MMT
Centimeter	CMT
Meter	MTR
Kilometer	KMT
Square millimeter	MMK
Square centimeter	CMK
Square meter	MTK
Cubic millimeter	MMQ
Cubic centimeter	CMQ
Cubic meter	MTQ
Liter	DMQ
Gram	GRM
Kilogram	KGM
Metric ton	TON
Piece	PCE

Processing outgoing

EDI Sub-System:

BAAN: The purchase unit from BAAN table field TFtdpur401.cupq is mapped to this position and converted with BAAN table TBecedi442.

Processing incoming

EDI Sub-System:

Transmission of the value from the message file.

BAAN:

Mapping to the BAAN table field TFtds401.cuqs and conversion with BAAN table TBecedi304.

Position	12	Field format	n..15	Field status	C
Field name	Ordered Quantity				

Description: This field contains the quantity ordered on this order line.

Format: NNNNNNNNNN.NNNN

Processing outgoing

EDI Sub-System:

BAAN: The ordered quantity from BAAN table field TFtdpur401.oqua is mapped to this position.

Processing incoming

EDI Sub-System: Transmission of the value from the message file.

BAAN: Mapping to the BAAN table field TFtdsls401.oqua

Position	13	Field format	n..14	Field status	C
Field name	Planned Delivery Date / Time				

Description: This field contains the date / time on which the delivery is planned or the customer wants to be delivered.

Processing outgoing

EDI Sub-System:

BAAN: The planned delivery date / time from BAAN table field TFtdpur401.ddta is mapped to this position.

Processing incoming

EDI Sub-System: Transmission of the value from the message file.

BAAN: Mapping to the BAAN table field TFtdsls401.ddta

Position	14	Field format	an..3	Field status	C
Field name	Purchase/Sales Price Unit				

Description: This field contains purchase/sales unit the price refers to. The coding was carried out on the basis of ODETTE-Standard ODDC 25:

Millimeter	MMT
Centimeter	CMT
Meter	MTR
Kilometer	KMT
Square millimeter	MMK
Square centimeter	CMK
Square meter	MTK
Cubic millimeter	MMQ
Cubic centimeter	CMQ
Cubic meter	MTQ
Liter	DMQ
Gram	GRM
Kilogram	KGM
Metric ton	TON
Piece	PCE

Processing outgoing

EDI Sub-System:

BAAN: The purchase price unit from BAAN table field TFtdpur401.cupp is mapped to this position and converted with BAAN table TBecedi442.

Processing incoming

EDI Sub-System:

Transmission of the value from the message file.

BAAN:

Mapping to the BAAN table field TFtdsls401.cups and conversion with BAAN table TBecedi304 is possible.

Position	15	Field format	an..5	Field status	C
Field name	Tax Code				

Description: This field contains the tax code. The conversion is done using the BAAN table TBecedi242 is filled.

Processing outgoing

EDI Sub-System:

BAAN: The tax code from BAAN table field TFtdpur401.cvat is mapped to this position and converted with BAAN table TBecedi446.

Processing incoming

EDI Sub-System:

BAAN: None.

Position	16	Field format	an..6	Field status	C
Field name	Country Code linked to tax code				

Description:

This field contains the Country Code which is linked to the tax code according to ODDC 6.

AT: Austria
 BE: Belgium
 CH: Switzerland
 DE: Federal Republik of Germany
 DK: Denmark
 ES: Spain
 FI: Finland
 FR: France
 GB: United Kingdom
 GR: Greece
 IE: Ireland
 IT: Italy
 LU: Luxembourg
 NL: Netherlands
 NO: Norway
 PT: Portugal
 SE: Sweden
 TR: Turkey
 YU: Yugoslavia

Processing outgoing

EDI Sub-System:

BAAN:

The country code from BAAN table field TFtdpur401ccty is mapped to this position and converted with BAAN table TBecedi440.

Processing incoming

EDI Sub-System:

BAAN:

None.

Position	17	Field format	n..8	Field status	C
Field name	Length				

Description: This field contains the length of the item based on an agreed physical unit.

Format: NNNNN.NN

Processing outgoing

EDI Sub-System:

BAAN: The length from BAAN table field
TFtdpur401.leng is mapped to this position .

Processing incoming

EDI Sub-System: Transmission of the value from the message file.

BAAN: Mapping to the BAAN table field
TFtdsls401.leng

Position	18	Field format	n..8	Field status	C
Field name	Width				

Description: This field contains the width of the item based on an agreed physical unit.

Format: NNNNN.NN

Processing outgoing

EDI Sub-System:

BAAN: The width from BAAN table field
TFtdpur401.widt is mapped to this position.

Processing incoming

EDI Sub-System: Transmission of the value from the message file.

BAAN: Mapping to the BAAN table field
TFtdsls401.widt

Position	19	Field format	n..8	Field status	C
Field name	Higth				

Description: This field contains the height or thickness of the item based on an agreed physical unit..

Format: NNNNN.NN

Processing outgoing

EDI Sub-System:

BAAN: The height from BAAN table field
TFtdpur401.thic is mapped to this position .

Processing incoming

EDI Sub-System: Transmission of the value from the message file.

BAAN: Mapping to the BAAN table field
TFtdsls401.thic

Position	20	Field format	n..15	Field status	C
Field name	Back Order Quantity				

Description: The quantity yet to be delivered by the supplier is registered as back order.

Format: NNNNNNNNNN.NNNN

Processing outgoing

EDI Sub-System:

BAAN: The back order quantity from BAAN table field
TFtdpur401.bqua is mapped to this position .

Processing incoming

EDI Sub-System: Transmission of the value from the message file.

BAAN: None.

Position	21	Field format	an..20	Field status	C
Field name	Discount Code 1				

Description: This field contains the Code for the first discount and has to be agreed with the relation.

Processing outgoing

EDI Sub-System:

BAAN: The code for the first discount from BAAN table field TFtdpur401.cdis is mapped to this position and converted using BAAN table TBecedi474.

Processing incoming

EDI Sub-System: Transmission of the value from the message file.

BAAN: Mapping to the BAAN table field TFtdsls401.cdis (1) and conversion using BAAN table TBecedi332.

Position	22	Field format	n..15	Field status	C
Field name	Order Line Discount Amount 1				

Description: This field contains the Amount of the Order Line Discount.

Format: NNNNNNNNNN.NNNN

Processing outgoing

EDI Sub-System:

BAAN: The amount of the first discount from BAAN table field TFtdpur401.ldam(1) is mapped to this position.

Processing incoming

EDI Sub-System: Transmission of the value from the message file.

BAAN: Mapping to the BAAN table field TFtdsls401.ldam (1)

Position	23	Field format	an..20	Field status	C
Field name	Discount Code 2				

Description: This field contains the Code for the second discount and has to be agreed with the relation.

Processing outgoing

EDI Sub-System:

BAAN: The code for the first discount from BAAN table field TFtdpur401.cdis(2) is mapped to this position and converted using BAAN table TBecedi474.

Processing incoming

EDI Sub-System: Transmission of the value from the message file.

BAAN: Mapping to the BAAN table field TFtdsls401.cdis (2) and conversion using BAAN table TBecedi332.

Position	24	Field format	n..15	Field status	C
Field name	Order Line Discount Amount 2				

Description: This field contains the Amount of the Order Line Discount.

Format: NNNNNNNNNN.NNNN

Processing outgoing

EDI Sub-System:

BAAN: The amount of the second discount from BAAN table field TFtdpur401.ldam(2) is mapped to this position.

Processing incoming

EDI Sub-System: Transmission of the value from the message file.

BAAN: Mapping to the BAAN table field TFtdsls401.ldam (2)

Position	25	Field format	an..20	Field status	C
Field name	Discount Code 3				

Description: This field contains the Code for the third discount and has to be agreed with the relation.

Processing outgoing

EDI Sub-System:

BAAN: The code for the first discount from BAAN table field TFtdpur401.cdis(3) is mapped to this position and converted using BAAN table TBecedi474.

Processing incoming

EDI Sub-System: Transmission of the value from the message file.

BAAN: Mapping to the BAAN table field TFtdsls401.cdis (3) and conversion using BAAN table TBecedi332.

Position	26	Field format	n..15	Field status	C
Field name	Order Line Discount Amount 3				

Description: This field contains the Amount of the Order Line Discount.

Format: NNNNNNNNNN.NNNN

Processing outgoing

EDI Sub-System:

BAAN: The amount of the third discount from BAAN table field TFtdpur401.ldam(3) is mapped to this position.

Processing incoming

EDI Sub-System: Transmission of the value from the message file.

BAAN: Mapping to the BAAN table field TFtdsls401.ldam (3)

Position	27	Field format	an..70	Field status	C
Field name	Order Line Text 1				

Description: This field contains the first part of the order line text.

Processing outgoing

EDI Sub-System:

BAAN: The first part of the order line text from BAAN table field TFtdpur401.txta(1) is mapped to this position.

Processing incoming

EDI Sub-System: Transmission of the value from the message file.

BAAN: Mapping to the BAAN table field TFtdsls401.txta (1)

Position	28	Field format	an..70	Field status	C
Field name	Order Line Text 2				

Description: This field contains the second part of the order line text.

Processing outgoing

EDI Sub-System:

BAAN: The second part of the order line text from BAAN table field TFtdpur401.txta(2) is mapped to this position .

Processing incoming

EDI Sub-System: Transmission of the value from the message file.

BAAN: Mapping to the BAAN table field TFtdsls401.txta (2)

Position	29	Field format	an3	Field status	C
Field name	Qualifier Tax Code ID				

Description: This field contains the Qualifier for the Tax Code ID on position 15.
 This tax code must be filled in BAAN table TBecedi240 to allow a conversion.

Processing outgoing

EDI Sub-System:

BAAN: The field is filled with the constant value "VAT".

Processing incoming

EDI Sub-System: The field is filled with the constant value "VAT".

BAAN: None.

Position	30	Field format	n..14	Field status	C
Field name	Order Date / Time				

Description: The order date / time of the order line is the date / time on which the order line was entered into the system. (YYYYMMDDHHMMSS)

Processing outgoing

EDI Sub-System:

BAAN: The order date / time of the purchase order line from BAAN table field TFtdpur401.odat is mapped to this position.

Processing incoming

EDI Sub-System: Transmission of the value from the message file.

BAAN: Mapping to the BAAN table field TFtdsls401.odat

Position	31	Field format	n..14	Field status	C
Field name	Planned Receipt Date / Time				

Description: This field contains the planned receipt date / time.

Format: YYYYMMDDHHMMSS.

Processing outgoing

EDI Sub-System:

BAAN:

Processing incoming

EDI Sub-System: Transmission of the value from the message file.
If not used, the date / time of position 14 must be filled in here too

BAAN: Mapping to the BAAN table field
TFtdsls401.prdt

Position	32	Field format	an..35	Field status	C
Field name	empty position				

Description: empty position, for future use

Processing outgoing

EDI Sub-System:

BAAN: None.

Processing incoming

EDI Sub-System:

BAAN: None.

Position	33	Field format	n..6	Field status	C
Field name	Order Line Discount Percentage 1				

Description: This field contains the first Percentage of the Order Line Discount.
 Format: NNN.NN
 Maximum is 100.00

Processing outgoing

EDI Sub-System:

BAAN: The percentage of the first discount from BAAN table field TFtdpur401.disc(1) is mapped to this position.

Processing incoming

EDI Sub-System: Transmission of the value from the message file.

BAAN: Mapping to the BAAN table field TFtds401.disc (1)

Position	34	Field format	n..6	Field status	C
Field name	Order Line Discount Percentage 2				

Description: This field contains the second Percentage of the Order Line Discount.
 Format: NNN.NN
 Maximum is 100.00

Processing outgoing

EDI Sub-System:

BAAN: The percentage of the first discount from BAAN table field TFtdpur401.disc(2) is mapped to this position.

Processing incoming

EDI Sub-System: Transmission of the value from the message file.

BAAN: Mapping to the BAAN table field TFtds401.disc (2)

Position	35	Field format	n..6	Field status	C
Field name	Order Line Discount Percentage 3				

Description: This field contains the first Percentage of the Order Line Discount.

Format: NNN.NN

Maximum is 100.00

Processing outgoing

EDI Sub-System:

BAAN: The percentage of the first discount from BAAN table field TFtdpur401.disc(3) is mapped to this position.

Processing incoming

EDI Sub-System: Transmission of the value from the message file.

BAAN: Mapping to the BAAN table field TFtds401.disc (3)

Position	36	Field format	n..6	Field status	C
Field name	Order Line Discount Percentage 4				

Description: This field contains the fourth Percentage of the Order Line Discount.

Format: NNN.NN

Maximum is 100.00

Processing outgoing

EDI Sub-System:

BAAN: The percentage of the fourth discount from BAAN table field TFtdpur401.disc(4) is mapped to this position.

Processing incoming

EDI Sub-System: Transmission of the value from the message file.

BAAN: Mapping to the BAAN table field TFtds401.disc (4)

Position	37	Field format	n..6	Field status	C
Field name	Order Line Discount Percentage 5				

Description: This field contains the fifth Percentage of the Order Line Discount.
Format: NNN.NN
Maximum is 100.00

Processing outgoing

EDI Sub-System:

BAAN: The percentage of the fifth discount from BAAN table field TFtdpur401.disc(5) is mapped to this position.

Processing incoming

EDI Sub-System: Transmission of the value from the message file.

BAAN: Mapping to the BAAN table field TFtdsls401.disc (5)

Position	38	Field format	n..6	Field status	C
Field name	Discount Code 4				

Description: This field contains the Code for the fourth discount and has to be agreed with the relation.

Processing outgoing

EDI Sub-System:

BAAN: The code for the first discount from BAAN table field TFtdpur401.cdis(4) is mapped to this position and converted using BAAN table Tbecedi474.

Processing incoming

EDI Sub-System: Transmission of the value from the message file.

BAAN: Mapping to the BAAN table field TFtdsls401.cdis (4) and conversion using BAAN table TBecedi332.

Position	39	Field format	n..6	Field status	C
Field name	Discount Code 4				

Description: This field contains the Code for the fifth discount and has to be agreed with the relation.

Processing outgoing

EDI Sub-System:

BAAN: The code for the first discount from BAAN table field TFtdpur401.cdis(5) is mapped to this position and converted using BAAN table Tbecedi474.

Processing incoming

EDI Sub-System: Transmission of the value from the message file.

BAAN: Mapping to the BAAN table field TFtdsls401.cdis (5) and conversion using BAAN table TBecedi332.

Position	40	Field format	n..15	Field status	C
Field name	Order Line Discount Amount 4				

Description: This field contains the Amount of the Order Line Discount.

Format: NNNNNNNNNN.NNNN

Processing outgoing

EDI Sub-System:

BAAN: The amount of the fourth discount from BAAN table field TFtdpur401.ldam(4) is mapped to this position.

Processing incoming

EDI Sub-System: Transmission of the value from the message file.

BAAN: Mapping to the BAAN table field TFtdsls401.ldam (4)

Position	41	Field format	n..15	Field status	C
Field name	Order Line Discount Amount 5				

Description: This field contains the Amount of the Order Line Discount.

Format: NNNNNNNNNN.NNNN

Processing outgoing

EDI Sub-System:

BAAN:

The amount of the second discount from BAAN table field TFtdpur401.ldam(5) is mapped to this position.

Processing incoming

EDI Sub-System:

Transmission of the value from the message file.

BAAN:

Mapping to the BAAN table field TFtdsls401.ldam (5)

Position	42	Field format	an..20	Field status	C
Field name	Discount Method 1				

Description:

This field contains the qualifier for the used Discount Method for the Order Line Discount. This means it is a code that indicates the way in which discounts are calculated if multiple discount levels are used. Discounts are calculated according to one of the following amounts:

Gross: the discount is calculated over the gross amount.

Net: the discount is calculated over the net amount. The net amount is the gross amount minus the net amount over the previous levels.

Used Qualifiers are:

“1” means gross

“2” means net

Processing outgoing**EDI Sub-System:****BAAN:**

The Qualifier of the first discount method from BAAN table field TFtdpur401.dmth(1) is mapped to this position.

Processing incoming**EDI Sub-System:**

Transmission of the value from the message file.

BAAN:

Mapping to the BAAN table field TFtdsls401.dmth(1)

Position	43	Field format	an..20	Field status	C
Field name	Discount Method 2				

Description: This field contains the qualifier for the used Discount Method for the Order Line Discount. discount method. This means it is a code that indicates the way in which discounts are calculated if multiple discount levels are used. Discounts are calculated according to one of the following amounts:

Gross: the discount is calculated over the gross amount.

Net: the discount is calculated over the net amount. The net amount is the gross amount minus the net amount over the previous levels.

Used Qualifiers are:

“1” means gross

“2” means net

Processing outgoing

EDI Sub-System:

BAAN:

The Qualifier of the second discount method from BAAN table field TFtdpur401.dmth(2) is mapped to this position.

Processing incoming

EDI Sub-System:

Transmission of the value from the message file.

BAAN:

Mapping to the BAAN table field TFtdsls401.dmth(2)

Position	44	Field format	an..20	Field status	C
Field name	Discount Method 3				

Description:

This field contains the qualifier for the used Discount Method for the Order Line Discount. This means it is a code that indicates the way in which discounts are calculated if multiple discount levels are used. Discounts are calculated according to one of the following amounts:

Gross: the discount is calculated over the gross amount.

Net: the discount is calculated over the net amount. The net amount is the gross amount minus the net amount over the previous levels.

Used Qualifiers are:

“1” means gross

“2” means net

Processing outgoing**EDI Sub-System:****BAAN:**

The Qualifier of the second discount method from BAAN table field TFtdpur401.dmth(3) is mapped to this position.

Processing incoming**EDI Sub-System:**

Transmission of the value from the message file.

BAAN:

Mapping to the BAAN table field TFtdsls401.dmth(3)

Position	45	Field format	an..20	Field status	C
Field name	Discount Method 4				

Description: This field contains the qualifier for the used Discount Method for the Order Line Discount. This means it is a code that indicates the way in which discounts are calculated if multiple discount levels are used. Discounts are calculated according to one of the following amounts:

Gross: the discount is calculated over the gross amount.

Net: the discount is calculated over the net amount. The net amount is the gross amount minus the net amount over the previous levels.

Used Qualifiers are:

“1” means gross

“2” means net

Processing outgoing

EDI Sub-System:

BAAN:

The Qualifier of the second discount method from BAAN table field TFtdpur401.dmth(4) is mapped to this position.

Processing incoming

EDI Sub-System:

Transmission of the value from the message file.

BAAN:

Mapping to the BAAN table field TFtdsls401.dmth(4)

Position	46	Field format	an..20	Field status	C
Field name	Discount Method 5				

Description:

This field contains the qualifier for the used Discount Method for the Order Line Discount. This means it is a code that indicates the way in which discounts are calculated if multiple discount levels are used. Discounts are calculated according to one of the following amounts:

Gross: the discount is calculated over the gross amount.

Net: the discount is calculated over the net amount. The net amount is the gross amount minus the net amount over the previous levels.

Used Qualifiers are:

“1” means gross

“2” means net

Processing outgoing**EDI Sub-System:****BAAN:**

The Qualifier of the second discount method from BAAN table field TFtdpur401.dmth(5) is mapped to this position.

Processing incoming**EDI Sub-System:**

Transmission of the value from the message file.

BAAN:

Mapping to the BAAN table field TFtdsls401.dmth(5).

Position	47	Field format	an..6	Field status	C
Field name	Manufacturer				

Description: A supplier of finished goods.

Processing outgoing

EDI Sub-System:

BAAN: The code for the manufacturer from BAAN table field TFtdpur401.cmnf is mapped to this position.

Processing incoming

EDI Sub-System: Transmission of the value from the message file.

BAAN: Mapping to the BAAN table field TFtdsls401.cmnf

Position	48	Field format	an..6	Field status	C
Field name	Product Class				

Description: User-definable item grouping data for distinguishing different groups of items within a product line. The product class is mainly used as a selection criterion for reporting.

Example

Product line	Product class
TV	Portable/Non-portable
VCR	Stereo/Mono
Walkman	Regular/Children's models

Processing outgoing

EDI Sub-System:

BAAN: The code for the product class from BAAN table field TFtdpur401.cmnf is mapped to this position.

Processing incoming

EDI Sub-System:

Transmission of the value from the message file.

BAAN:

Mapping to the BAAN table field TFtdsls401.cmnf

Position	49	Field format	n..19	Field status	C
Field name	Confirmed Delivery Date / Time				

Description: This date is the confirmed delivery date /time of the purchase order.

Processing outgoing

EDI Sub-System:

BAAN: The date/time from BAAN table field TFtdpur401.ddtb is mapped to this position.

Processing incoming

EDI Sub-System: None

BAAN: None

Position	50	Field format	n..14	Field status	C
Field name	Forwarding Agent				

Description: This field contains the Code for the forwarding agent used for this position. This code has to be agreed upon with th partner.

Processing outgoing

EDI Sub-System:

BAAN: The code of the forwarding agent from BAAN table field TFtdpur401.cfrw is mapped to this position. Conversion via BAAN table TBecedi456.

Processing incoming

EDI Sub-System: Transmission of the value from the message file.

BAAN: Mapping to the BAAN table field TFtdsls401.cfrw after conversion via BAAN table TBecedi318.

Position	51	Field format	an..20	Field status	C
Field name	Ship from Bussiness Partner				

Description: This field contains the Code for the Ship From Business Partner. Outgoing this code means from which business partner the goods has to be delivered. Incomming this code has to be converted to the warehouse, from which the goods should be shipped.

Processing outgoing

EDI Sub-System:

BAAN: The code of the ship from business partner from BAAN table field TFtdpur401.sfbp is mapped to this position after conversion with BAAN table TBecedi468.

Processing incoming

EDI Sub-System: Transmission of the value from the message file.

BAAN: Mapping to the BAAN table field TFtdsls401.cwar after conversion with BAAN table TBecedi355.

Position	52	Field format	an4	Field status	C
Field name	Qualifier Address/Partner				

Description: This field contains the Qualifier for the Partner Code stated on position 51. The code is "SFBP"

Processing outgoing

EDI Sub-System:

BAAN: The qualifier from BAAN table field TFecedi224.code is mapped to this position.

Processing incoming

EDI Sub-System: Transmission of the value from the message file or fixed value "SFBP"

BAAN: Used for conversion of position 51.

Position	53	Field format	an..20	Field status	C
Field name	Warehouse Code				

Description: This field contains the Code of the warehouse the goods has to be shipped to.

Processing outgoing

EDI Sub-System:

BAAN: The code of the warehouse from BAAN table field TFtdpur401.cwar is mapped to this position. Conversion via BAAN table TBecedi462.

Processing incoming

EDI Sub-System: Transmission of the value from the message file.

BAAN: Mapping to the BAAN table field TFtdsls401.stbp after conversion via BAAN table TBecedi328.

Position	54	Field format	an4	Field status	C
Field name	Qualifier Warehouse Code				

Description: This field contains the Qualifier regarding to the warehouse code conversion. The Qualifier is "STBP".

Processing outgoing

EDI Sub-System:

BAAN: The qualifier from BAAN table field TFecedi224.code is mapped to this position. Qualifier for position 53.

Processing incoming

EDI Sub-System: Transmission of the value from the message file or fixed value "STBP".

BAAN: Used for conversion of Position 53.

Position	55	Field format	n..13	Field status	C
Field name	Orderd Amount				

Description: This field contains the Orderd Amount of this order line.

Processing outgoing

EDI Sub-System:

BAAN: The Factor from BAAN table field TFtdpur401.oamt is mapped to this position.

Processing incoming

EDI Sub-System: None.

BAAN: None.

Position	56	Field format	n..14	Field status	C
Field name	Qualifier				

Description: This field contains the Qualifier "ZZ" used for Conversion of addresses..

Processing outgoing

EDI Sub-System:

BAAN: The constant value "ZZ" is mapped to this position.

Processing incoming

EDI Sub-System: The fixed value 'ZZ' is entered on this position.

BAAN: Used for conversion.

Position	57	Field format	an7	Field status	C
Field name	Qualifier Sold to Business Partner				

Description: This field contains the Qualifier for the Sold to Business Partner Conversion. The Qualifier is stated as 'STBP'.

Processing outgoing

EDI Sub-System:

BAAN:

Processing incoming

EDI Sub-System: The fixed value 'STBP' is mapped to this position.

BAAN: Used for conversion.

Position	58	Field format	an7	Field status	M
Field name	Data record end sign				

Description: This field indicates the end of the data record. It contains the constant value 'SA5_END'.

Processing outgoing

EDI Sub-System:

BAAN: This field will be filled with the constant value 'SA5_END'.

Processing incoming

EDI Sub-System: This field will be filled with the constant value 'SA5_END'.

BAAN: None

SA6 Ship from Business Partner Address per Order Line

Status : Conditional
 Frequency : Once per Order Position
 Description: This data record is related to one Order Position.

First Appearance: Warehouse Address (Address Qualifier: CWAR)

<i>ORDER INHOUSE FORMAT</i>					<i>Mapping from Application Table Fields</i>		<i>Mapping to Application Fields</i>	
<i>Pos</i>	<i>FIELD DESCRIPTION</i>	<i>Key</i>	<i>ST</i>	<i>FM</i>	<i>Table Field</i>	<i>Action</i>	<i>Table Field</i>	<i>Action</i>
1.	Kind of data record	O/I	M	an3	SA6		SA6	
2.	Message reference	O/I	M	an..14	ecedi701.bano		ecedi702.bano	
3.	Identification of the sender	O/I	M	an..17	ecedi020.neta	Conversion	tdsls400.ofbp	Conversion
4.	Order Number	O/I	M	n..9 an..30	tdpur400.orno		tdsls400.corn	
5.	Order Position Number		M	n..5 an..16	tdpur401.pono		tdsls401.copn	
6.	Address Qualifier Warehouse Address		M	an4	"CWAR"			
7.	Warehouse Address Country		C	an..6	tccom130.ccty	ORD9	tccom130.ccty	Code and Conversion

<i>ORDER INHOUSE FORMAT</i>					<i>Mapping from Application Table Fields</i>		<i>Mapping to Application Fields</i>	
<i>Pos</i>	<i>FIELD DESCRIPTION</i>	<i>Key</i>	<i>ST</i>	<i>FM</i>	<i>Table Field</i>	<i>Action</i>	<i>Table Field</i>	<i>Action</i>
8.	Warehouse Address first part of the name		C	an..35	tccom130.nama	ORD9	tccom130.nama	
9.	Warehouse Address second part of the name		C	an..30	tccom130.namb	ORD9	tccom130.namb	
10.	Warehouse Address third part of the name		C	an..30	tccom130.namc	ORD9	tccom130.namc	
11.	Warehouse Address 2		C	an..30	tccom130.namd	ORD9	tccom130.namd	
12.	Warehouse Address City		C	an..30	tccom130.name	ORD9	tccom130.name	
13.	ILN Code, Warehouse Address		C	an..30	tccom130.namf	ORD9	tccom130.namf	
14.	Warehouse Address Zip Code		C	an..10	tccom130.pstc	ORD9	tccom130.pstc	
15.	Warehouse Address Tax Id		C	an..20	tccom130.fovn	ORD9	tccom130.fovn	
16.	TAX Code Id Qualifier		M	an3	“VAT”	ORD9	“VAT”	
17.	Warehouse Address State / Province		C	an2	tccom130.cste	ORD9	tccom130.cste	

<i>ORDER INHOUSE FORMAT</i>					<i>Mapping from Application Table Fields</i>		<i>Mapping to Application Fields</i>	
<i>Pos</i>	<i>FIELD DESCRIPTION</i>	<i>Key</i>	<i>ST</i>	<i>FM</i>	<i>Table Field</i>	<i>Action</i>	<i>Table Field</i>	<i>Action</i>
18.	Warehouse Address Telephone Number		C	an..15	tccom130.telp	ORD9	tccom130.telp	
19.	Warehouse Address Telex Number		C	an..15	tccom130.telx	ORD9	tccom130.telx	
20.	Warehouse Address Fax Number		C	an..15	tccom130.tefx	ORD9	tccom130.tefx	
21.	Warehouse Address GEO Code		C	an..10	tccom130.geoc	ORD9	tccom130.geoc	
22.	Warehouse Address House Number		C	an..10	tccom130.hono	ORD9	tccom130.hono	
23.	Warehouse Address P. O. Box Number		C	an..10	tccom130.pobn	ORD9	tccom130.pobn	
24.	Data record end sign		M	an7	SA6_END	ORD9	SA6_END	

Evaluation Expression: ORD9 (strip(tpdur401.sfad) <> "" and tdpur401.sfad <>tccom121.cadr)

Detailed description:	Warehouse Address per order line
Kind of data record:	SA6 Warehouse Address per order line

Position	1	Field format	an3	Field status	M
Field name	Kind of data record		(Key field out/in)		

Description: This field identifies the kind of data record in the message block. It contains the constant value 'SA6'.

Processing outgoing

EDI Sub-System:

BAAN: This field will be filled with the constant value 'SA6'.

Processing incoming

EDI Sub-System: This field will be filled with the constant value 'SA6'.

BAAN:

Position	2	Field format	an..14	Field status	M
Field name	Message reference		(Key field out/in)		

Description: This field identifies all connected data records of one order. The numbering of the message reference, which has to be clear by Order, helps to control the chronological order of the Orders and the complete transmission.

Processing outgoing

EDI Sub-System:

BAAN: Refer to data record SA5.

Processing incoming

EDI Sub-System: Refer to data record SA5

BAAN:

Position	3	Field format	an..17	Field status	M
Field name	Identification of the sender		(Key field out)		

Description: This field contains the identification code of the sender.

Processing outgoing

EDI Sub-System:

BAAN: Refer to data record SA5

Processing incoming

EDI Sub-System: Refer to data record SA5

BAAN: Refer to data record SA5

Position	4	Field format	an..9/an..30	Field status	M
Field name	Order Number		(Key field in/out)		

Description: This field contains the order number.

Processing outgoing

EDI Sub-System: None.

BAAN: Refer to data record SA5.

Processing incoming

EDI Sub-System:

BAAN: Refer to data record SA5

Position	5	Field format	an..9/an..30	Field status	M
Field name	Order Position Number			(Key field in/out)	

Description: This field contains the order position number.

Processing outgoing

EDI Sub-System: None.

BAAN: Refer to data record SA5.

Processing incoming

EDI Sub-System:

BAAN: Refer to data record SA5

Position	6	Field format	an4	Field status	M
Field name	Address Qualifier Warehouse Address				

Description: This field contains the Qualifier which identifies the next data set as an ship from or an ship to address.

CWAR The following data is the Ship to (warehouse) address

This qualifier must be entered in BAAN table TBecedi224 regarding to the used organization.

Processing outgoing

EDI Sub-System:

BAAN: The value "CWAR" or is filled in from BAAN table field ecedi224.code.

Processing incoming

EDI Sub-System: The value "CWAR" is filled in this position.

BAAN: Mapping to BAAN table field TFtdsls042.ckor and Conversion with TBecedi224..

Position	7	Field format	an..6	Field status	C
Field name	Warehouse Address Country				

Description: This field contains the Country of the Address. The following country codes are defined in BAAN table TBecedi226 according to ODDC 6

AT: Austria
 BE: Belgium
 CH: Switzerland
 DE: Federal Republik of Germany
 DK: Denmark
 ES: Spain
 FI: Finland
 FR: France
 GB: United Kingdom
 GR: Greece
 IE: Ireland
 IT: Italy
 LU: Luxembourg
 NL: Netherlands
 NO: Norway
 PT: Portugal
 SE: Sweden
 TR: Turkey
 YU: Yugoslavia

Processing outgoing

EDI Sub-System:

BAAN: The country code of the warehouse address from BAAN table field TFtdpur042.ccty or tccom130.ccty is mapped to this position and converts with BAAN table TBecedi440.

Processing incoming

EDI Sub-System: Transmission of the value from the message file.

BAAN: Mapping to the BAAN table field TFtccom130.ccty and conversion with BAAN table TBecedi302.

Position	8	Field format	an..35	Field status	C
Field name	WarehouseAddress First part of Name				

Description: This field contains the first part of the name.

Processing outgoing

EDI Sub-System:

BAAN: The First part of the Name from BAAN table field TFtccom130.nama is mapped to this position.

Processing incoming

EDI Sub-System: Transmission of the value from the message file.

BAAN: Mapping to the BAAN table field TFtccom130.nama

Position	9	Field format	an..30	Field status	C
Field name	Warehouse Address Second part of Name				

Description: This field contains the second part of the name.

Processing outgoing

EDI Sub-System:

BAAN: The Second part of the Name from BAAN table field TFtccom130.namb is mapped to this position.

Processing incoming

EDI Sub-System: Transmission of the value from the message file.

BAAN: Mapping to the BAAN table field TFtccom130.namb

Position	10	Field format	an..30	Field status	C
Field name	Warehouse Address 3rd part of the name				

Description: This field contains the first part of the Warehouse Address.

Processing outgoing

EDI Sub-System:

BAAN: The first part of the Address from BAAN table field TFtccom130.namc is mapped to this position.

Processing incoming

EDI Sub-System: Transmission of the value from the message file.

BAAN: Mapping to the BAAN table field TFtccom130.namc

Position	11	Field format	an..30	Field status	C
Field name	Warehouse Address 2				

Description: This field contains the second part of the warehouse address.

Processing outgoing

EDI Sub-System:

BAAN: The second part of the warehouse Address from BAAN table field TFtccom130.namd is mapped to this position.

Processing incoming

EDI Sub-System: Transmission of the value from the message file.

BAAN: Mapping to the BAAN table field TFtccom130.namd

Position	12	Field format	an..30	Field status	C
Field name	Warehouse Address City				

Description: This field contains the name of the City.

Processing outgoing

EDI Sub-System:

BAAN: The name of the City from BAAN table field TFtccom130. name is mapped to this position.

Processing incoming

EDI Sub-System: Transmission of the value from the message file.

BAAN: Mapping to the BAAN table field TFtccom130.name

Position	13	Field format	an..30	Field status	C
Field name	ILN Warehouse Code / further information province or country				

Description: This field contains further information to the City (province/country)

Processing outgoing

EDI Sub-System:

BAAN: The ILN-Code from BAAN table field TFtccom130.namf is mapped to this position.

Processing incoming

EDI Sub-System: Transmission of the value from the message file.

BAAN: The ILN-Code is mapped to BAAN table field TFtccom130.namf.

Position	14	Field format	an..10	Field status	C
Field name	Warehouse Address Zip Code				

Description: This field contains the postal or zip Code referring to the Warehouse Address.

Processing outgoing

EDI Sub-System:

BAAN: The Zip Code from BAAN table field TFtccom130.pstc is mapped to this position.

Processing incoming

EDI Sub-System: Transmission of the value from the message file.

BAAN: Mapping to the BAAN table field TFtccom130.pstc

Position	15	Field format	an..20	Field status	C
Field name	Warehouse Address Tax ID				

Description: This field contains the Tax ID.

Processing outgoing

EDI Sub-System:

BAAN: The tax ID of BAAN table field TFtccom130.fovn is mapped to this position.

Processing incoming

EDI Sub-System: Transmission of the value from the message file.

BAAN: Mapped to BAAN table field tccom130.fovn.

Position	16	Field format	an3	Field status	M
Field name	Tax Code ID Qualifier				

Description: This field contains the Tax Code ID Qualifier "VAT".

Processing outgoing

EDI Sub-System:

BAAN: This field is filled with the constant value "VAT".

Processing incoming

EDI Sub-System:

BAAN: None

Position	17	Field format	an2	Field status	C
Field name	Warehouse Address State/Province				

Description: This field contains the Warehouse Address State / Province.

Processing outgoing

EDI Sub-System:

BAAN: The State /Province Code from BAAN table field Tftccom130.cste is mapped to this position.

Processing incoming

EDI Sub-System: Transmission of the value from the message file.

BAAN: Mapped to BAAN table field tccom130.cste.

Position	18	Field format	an..15	Field status	C
Field name	Warehouse Address Telephon Number				

Description: This field contains the Warehouse Address Telephone Number.

Processing outgoing

EDI Sub-System:

BAAN: The telephone number of BAAN table field TFtccom130.telp is mapped to this position.

Processing incoming

EDI Sub-System: Transmission of the value from the message file.

BAAN: Mapped to BAAN table field tccom130.telp.

Position	19	Field format	an..15	Field status	C
Field name	Warehouse Address Telex Number				

Description: This field contains the Warehouse Address Telex Number.

Processing outgoing

EDI Sub-System:

BAAN: The telex number of BAAN table field TFtccom130.telx is mapped to this position.

Processing incoming

EDI Sub-System: Transmission of the value from the message file.

BAAN: Mapped to BAAN table field tccom130.telx.

Position	20	Field format	an..15	Field status	C
Field name	Warehouse Address Fax Number				

Description: This field contains the Warehouse Address Faxnumber.

Processing outgoing

EDI Sub-System:

BAAN: The Faxnumber of BAAN table field TFtccom130.tefx is mapped to this position.

Processing incoming

EDI Sub-System: Transmission of the value from the message file.

BAAN: Mapped to BAAN table field tccom130.tefx.

Position	21	Field format	an..10	Field status	C
Field name	Warehouse Address GEO Code				

Description: This field contains the Warehouse Address GEO-Code.

Processing outgoing

EDI Sub-System:

BAAN: The GEO-Code of BAAN table field TFtccom130.deoc is mapped to this position.

Processing incoming

EDI Sub-System: Transmission of the value from the message file.

BAAN: Mapped to BAAN table field tccom130.geoc.

Position	22	Field format	an..10	Field status	C
Field name	Warehouse Address Housenumber				

Description: This field contains the Warehouse Address housenumber of the address.

Processing outgoing

EDI Sub-System:

BAAN: The housenumber of BAAN table field TFtccom130.hono is mapped to this position.

Processing incoming

EDI Sub-System: Transmission of the value from the message file.

BAAN: Mapped to BAAN table field tccom130.hono.

Position	23	Field format	an..10	Field status	C
Field name	Warehouse Address P.O.Box Number				

Description: This field contains the Warehouse Address P.O. Box Number.

Processing outgoing

EDI Sub-System:

BAAN: The P.O. Box Number of BAAN table field TFtccom130.pobn is mapped to this position.

Processing incoming

EDI Sub-System: Transmission of the value from the message file.

BAAN: Mapped to BAAN table field tccom130.pobn.

Position	24	Field format	an7	Field status	M
Field name	Data record end sign				

Description: This field indicates the end of the data record. It contains the constant value 'SA6_END'.

Processing outgoing

EDI Sub-System:

BAAN: This field will be filled with the constant value 'SA6_END'.

Processing incoming

EDI Sub-System: This field will be filled with the constant value 'SA6_END'.

BAAN: None